

VB2 Large Capacity, Well-rounded Design

VB1 Ultra-fast I/O Terminals, Take Advantage

VB0 Highly Reliable and Suitable for Various Applications

VB PLC family

A Complete Control Solution



PROGRAMMABLE CONTROLLER

A Remarkable Product Must Be "Consumer Inside"

The market demands are the starting point of all products; To create a good product should keep the demands in mind.

Based on the idea of "meet the future market demands", VIGOR in order to satisfy the market needs, from the visible, audible and imaginable customer request, by way of the professionally R & D working group to develop this VB Series Programmable Controller. VIGOR's expertise is more than the technical knowledge, we also have the excellently complete product lines, which are correspond with the requires of real operations and market demands.

The VB Series PLC not only provides the feature of new generation compact size high performance PLC, but also offers innovation design close to the market, which will provide a satisfied control for diversified requires.

The VB Series Programmable Controller is following the concept of "Consumer Inside", we expecting your appreciation and affirmation.

Patented Functions, Increasing Your Product Value

The state-of-the-art Multi-Functional Display will effectively enhance product added value.

Any machine may have potential breakdown problems. When a trouble occurs, the machine designers would like to provide the note of problem for machine operators properly then it can help the trouble-shooter to solve the problem and reduce losses. But due to the limited budget, this important function is always omitted and discarded.

Now, the VB Series PLC penetrates this requirement. At the PLC main unit, we cleverly install a LED Multi-Functional Display, which allows users to show the machinery operation status and error messages easily and clearly.

Furthermore, the Multi-Functional Display can be used for demonstrate text messages and graphics. Also, when it cooperates with some input buttons, which becomes the display interface of data access unit.

Such a pleasant function have already obtained a patent license. It is an advantaged tool for enhancing product added value and competitiveness. And, this perfect ideal will not increase any additional costs.



Attentively Innovative Design, Effectively Reducing Labor Costs

The barrier style wire terminal is strong and reliable which seems to be the common type that for commercial PLC. But people are concerned about the assembly line which is always spend too much time and make mistakes easily, as well as it has difficulties in the maintenance.

VIGOR has found such demands, the VB Series PLC delivers a solution, it come up with a series of connector units. The Main Unit, Expansion Unit and Expansion Module of the VB series come in 2 types: the barrier terminal and ATX connector, to satisfy various requirements and ideas.

For avoiding any trouble at making the connecting wires, all the connector-type VB Series PLCs come with ATX connectors and 2-meter wires.

The "fast linkage" characteristic of the connector-type PLC units will efficiently reduce wiring labor, assembling duration and mistakes; moreover, it has the advantage of easy maintenance. Particularly for machines in the mass-production industry, this efficiency stands out significantly.

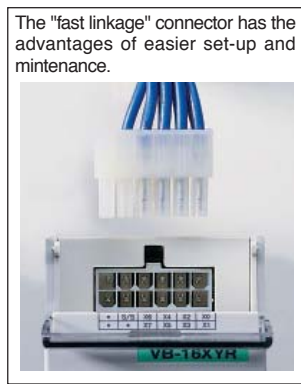
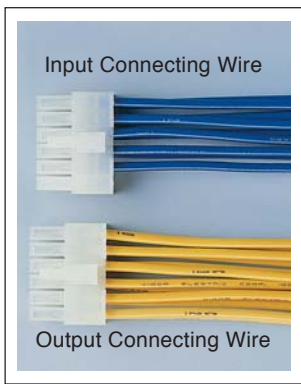
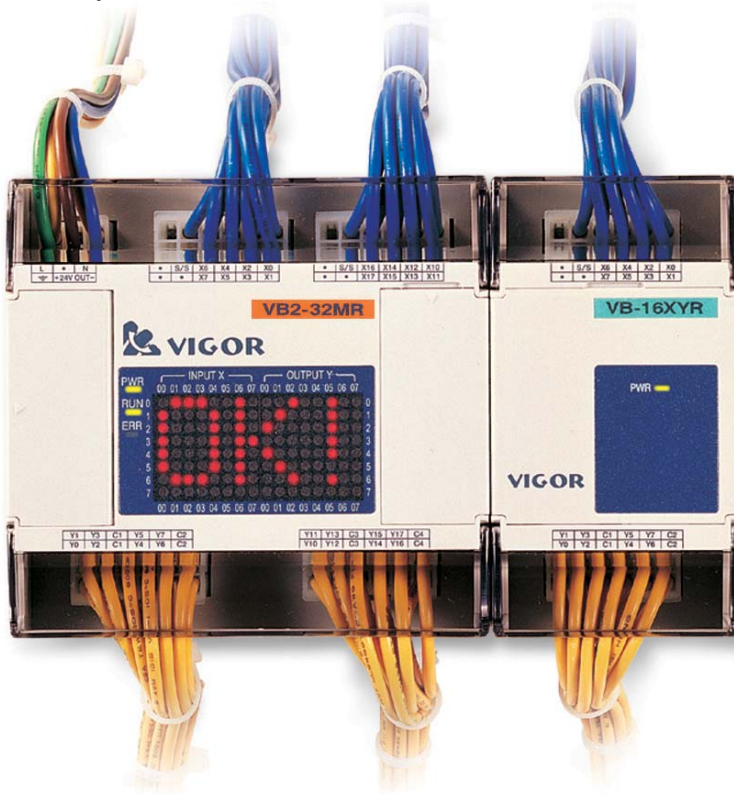

- **System Composition** 4
- **The VB Series Main Unit** 5
 - Features.....6
 - Multi-Functional Display.....7
 - Performance Specification.....8
 - Instruction Tables.....9
 - Regulation Specifications.....10
 - Power Specification.....10
 - Notes for Expansions.....10
 - Input Point Specification.....11
 - Output Point Specification.....11
- **Formation of Communication System**...12
 - Communication Expansion Card.....13
 - VB-CADP Dual-Ports Communication Expansion Module.....14
 - VB-485A RS-485 Communication Expansion Module.....15
 - VB-1COM Serial Link Communication Module.....15
- **Communication Operation Mode**.....16
 - Computer Link.....16
 - Easy Link.....16
 - Parallel Link.....17
 - CPU Link.....17
 - MODBUS Communication.....18
 - MODEM Communication.....18
 - MODEM Dialing.....18
 - Non Protocol Communication.....19
- **Special Module**.....20
 - VB-2VC 2-Channel value controls.....20
 - VB-2DA 2-Channel 12-bit Analog Output Module.....20
 - VB-4DA 4-Channel 8-bit Analog Output Module.....20
 - VB-4AD 4-Channel 12-bit Analog Input Module.....21
 - VB-6A/VB-3A Analog Input/Output Module.....21
 - VB-8T/VB-4T Temperature Input Module.....22
 - VB-4PT/VB-2PT Temperature Input Module.....22
 - VB-2LC/VB-1LC Temperature Control Module.....23
 - VB-1PG Single Axis Pulse Output Positioning Control Module.....24
 - VB-1HC High Speed Counter Module.....24
- **Accessories**.....25
 - VB-PWR Power Expansion Module.....25
 - VB-30PS Power Supply Module.....25
 - DAP-100 Configuration Panel.....25
 - Memory Slot Expansion Cards.....25
 - Connecting Cables.....26
- **Dimensions and Terminal Layouts**.....27
 - 94mm Model.....27
 - 48mm Model.....28
- **Programming Tool**.....29
 - MS Windows®-based Programming Tool : Ladder Master.....30
 - Palm OS™-based PDA Programming Tool : NeoTouch.....30
- **VB Series Product List**.....31

◆ Programming Tool



MS Windows® based
Programming Tool
Ladder Master



PDA (Palm® OS) based
Programming Tool
NeoTouch

◆ RTC/Memory Expansion Cards



RTC Expansion Card
VB-RTC



Program Memory + RTC Card
VB-MP1R



Data Bank + RTC Expansion Card
VB-DB1R

◆ Expansion Unit



VB-32E ★-◆	16-point Input 16-point Output
VB-32XY ★	16-point Input 16-point Output

Barrier Terminal Block
Style Expansion Unit

VB-32XY is the expansion
module without power supply.



VB-32E ★-◆C	16-point Input 16-point Output
VB-32XY ★C	16-point Input 16-point Output

ATX Connector Style
Expansion Unit

VB-32XY-C is the expansion
module without power supply.

◆ Communication Expansion



RS-232 Communication
Expansion Card VB-232



RS-422/RS-485 Communication
Expansion Card VB-485



RS-485 Communication
Expansion Module VB-485A



Dual Communication
Expansion Module VB-CADP

◆ Main Units



Barrier Terminal Block Style
Main Unit

VB2-16M ★-◆	8-point Input	8-point Output
VB2-32M ★-◆	16-point Input	16-point Output
VB1-14MT-D	8-point Input	6-point Output
VB1-24MT-D	14-point Input	10-point Output
VB1-32MT-D	16-point Input	16-point Output
VB0-14M ★-◆	8-point Input	6-point Output
VB0-20M ★-◆	12-point Input	8-point Output
VB0-28M ★-◆	16-point Input	12-point Output
VB0-32M ★-◆	16-point Input	16-point Output

VB1-14MT is the 48mm main unit without
Memory Card Slot and I/O Expansion Slot.



ATX Connector Style Main Unit

VB2-32M ★-◆C	16-point Input	16-point Output
VB0-32M ★-◆C	16-point Input	16-point Output

★ Indicates the output type
R: Relay Output
T: NPN Transistor Output
P: PNP Transistor Output

◆ Indicates the power type
A: AC100-240V – 15%/+ 10%
D: DC24V – 15%/+ 20%

◆ Expansion Module



VB-16XY ★	8-point Input 8-point Output
VB-16X	16-point Input
VB-16Y ★	16-point Output
VB-8XY ★	4-point Input 4-point Output
VB-8X	8-point Input
VB-8Y ★	8-point Output

Barrier Terminal Block
Style Expansion Unit



VB-16XY ★-C	8-point Input 8-point Output
VB-16X-C	16-point Input
VB-8X-C	8-point Input
VB-8Y ★-C	8-point output

ATX Connector Style
Expansion Module

◆ Special Module



VB-2VC	2-channel Valve Controls
VB-4AD	4-channel 12-bit Analog Inputs
VB-2DA	2-channel 12-bit Analog Outputs
VB-4DA	4-channel 8-bit Analog Outputs
VB-3A	2-channel 12-bit Analog Inputs 1-channel 12-bit Analog Output
VB-6A	4-channel 12-bit Analog Inputs 2-channel 12-bit Analog Outputs
VB-4T	4-channel J/K TC Temperature Inputs
VB-8T	8-channel J/K TC Temperature Inputs
VB-2PT	2-channel PT-100 Temperature Inputs
VB-4PT	4-channel PT-100 Temperature Inputs
VB-1LC	1-channel Temperature Controls
VB-2LC	2-channel Temperature Controls
VB-1HC	Single channel 45KHz High Speed Counter
VB-1COM	A Serial Link Communication Interface
VB-PWR	24W Power Expansion

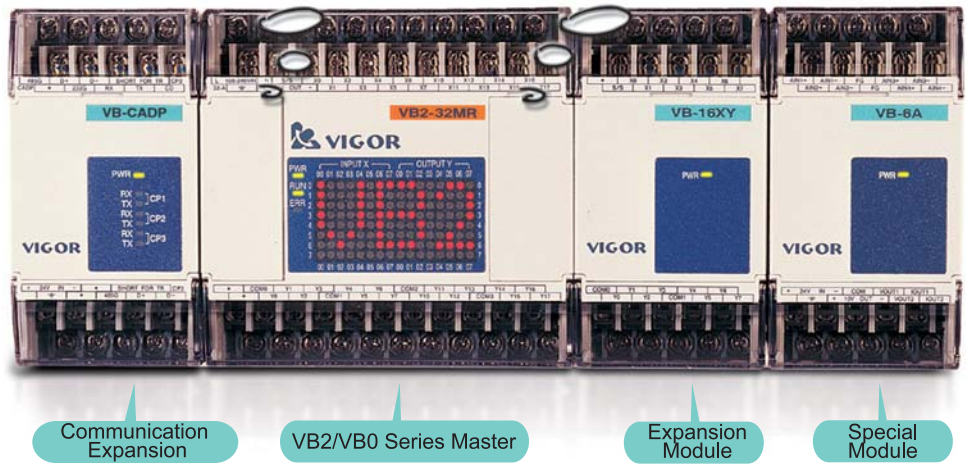
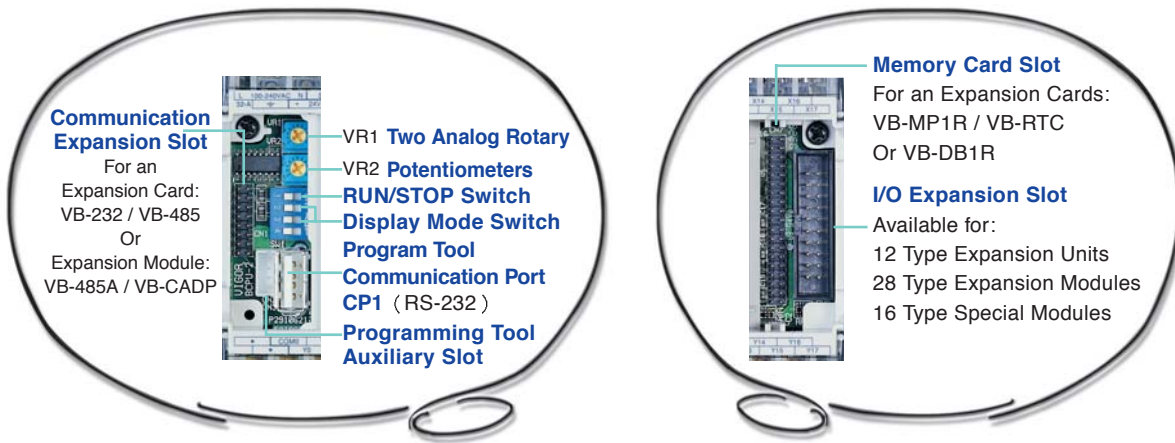

- The Analog Rotary Potentiometers (VR1 and VR2) provide number values (0~255) which can be used for data inputs (i.e. changing timer settings). If they incorporate with the Multi-Functional Display, the PLC will have a flexible performance.
- The Main Unit has a built-in RUN/STOP switch which allows convenient control to run or stop the PLC.
- The Display Mode Switches let the LCD matrix screen become its I/O status display or the Multi-Functional Display.
- The Communication Expansion Slot can be used for RS-232 or RS-422/485 communication expansion cards (VB-232 / VB-485) or modules (VB-485A / VB-CADP).
- The Memory Card Slot can be used for program memory (VB-MP1R), Real Time Clock (VB-RTC) or Data Bank (VB-DB1R) expansion card.
- The I/O Expansion Slot can be used for connecting various I/O expansion units/modules or special modules.
- The Programming Tool Communication Port is a RS-232 interface (USB A-type outlet), it can be used to connect with programming tool (computer or PDA), HMI (Human-Machine Interface) or SCADA (Supervisor Control And Data Acquisition). And also by this port, the remote program modification and data monitoring through a MODEM are available.
- The PLC could communicate via either the Programming Tool Auxiliary Port (JST 4P outlet) or Programming Tool Communication Port CP1 (USB A-type outlet).



Each Main Unit has a built-in a RS-232 interface. The PLC just needs a transmission cable, easy to do programming and monitoring via a computer or PDA.

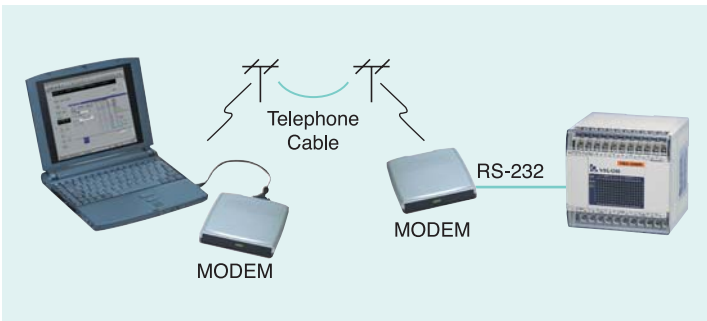

Program and data can be monitored, uploaded or downloaded by the programming tool from remote locations via MODEMS.

◆ VB1 series High Speed I/O function

VB1 main unit in the VB-PLC family is designed specifically for positioning control. The build-in 4-point High Speed Pulse Output, 20 KHz from Y0, Y1 and 200 KHz from Y2, Y3, enable the positioning control to be carried out easily in a faster and more precise manner through using the positioning control instruction. Moreover, for the High Speed Input, not only did it preserve the VB series interrupt input and high speed counter functions, some improvements have been made to it by adding a 2-point AB-phase high speed counter hardware which can count the pulse input signal frequency up to 200 KHz. The conjunction of the high speed pulse output and the high speed counter hardware can complete a close loop positioning control to satisfy the need for accuracy.

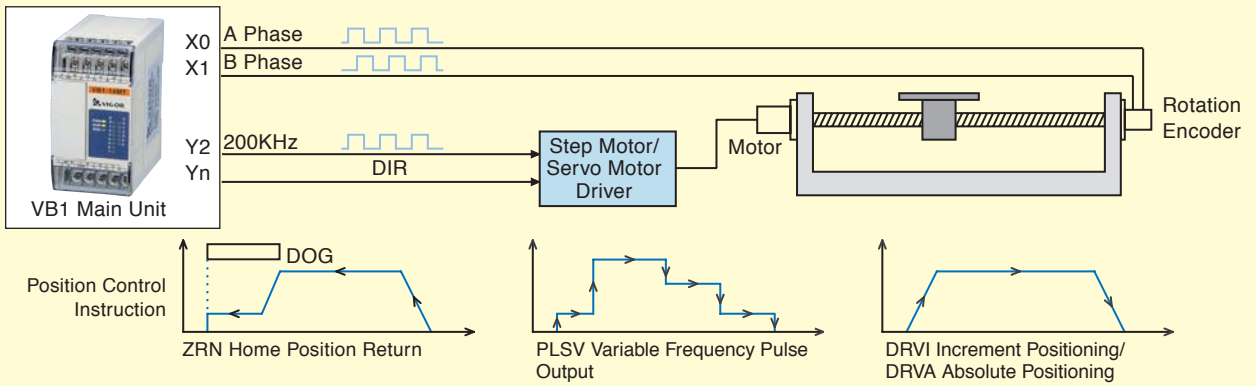

◆ PID control with Auto Tuning(AT) mechanism

VB series PLC offer more precise process control via the PID control instruction which can be executed repeatedly. With the premium Auto Tuning(AT) mechanism, the PID parameter setting could never be easier.

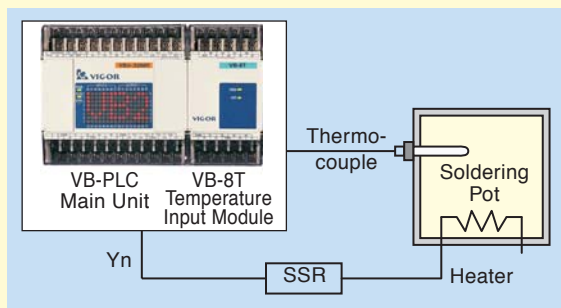

◆ Data Bank Provides Large Capacity of Data Storage Function

The Main Unit has 7,680 general and 512 latched data registers. To insert a VB-DB1R Data Bank expansion card, it will get extra 128,000 latched data registers, for a storage of huge data is required.

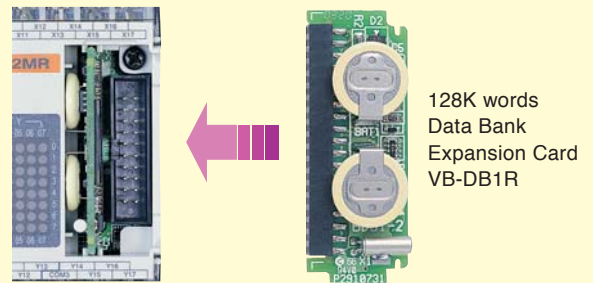

◆ VB0、VB2 Series Pulse Output Function

The Main Unit has two points (Y0, Y1) of pulse output (up to 7 kHz). The output pulse can drive the step motor or servo motor directly. The additional VB-1PG positioning control module is designed for the demand of higher frequency (up to 100 kHz) pulse output.

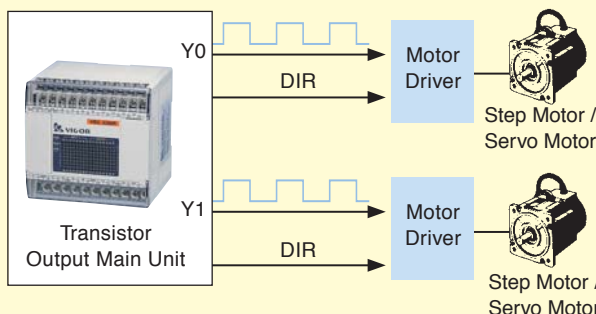

◆ Interrupt Input and High-Speed Counter Function

The Main Unit has 6 points (X0~X5) of high-speed input which can be used as the interrupt and high-speed counter inputs. At most, it can be connected to 6 single-phase high-speed counters or 2 AB-phase rotation encoders. The additional VB-1HC high-speed counter module is designed for the demand of higher frequency (up to 45 kHz) pulse input.

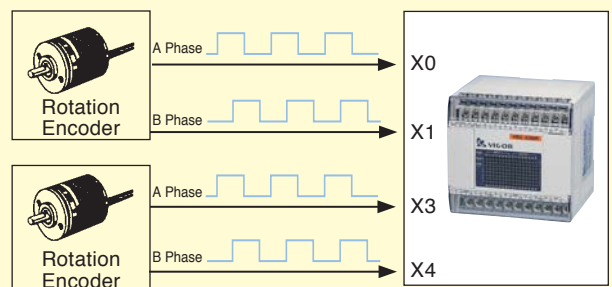

◆ Multi-Functional Display

This state-of-the-art Multi-Functional Display can be used to show the error messages, procedural flows, texts and graphics, etc.

When the Multi-Functional Display cooperates with input buttons, it becomes a part of data access interface. A better utilization will help enhance product added value.

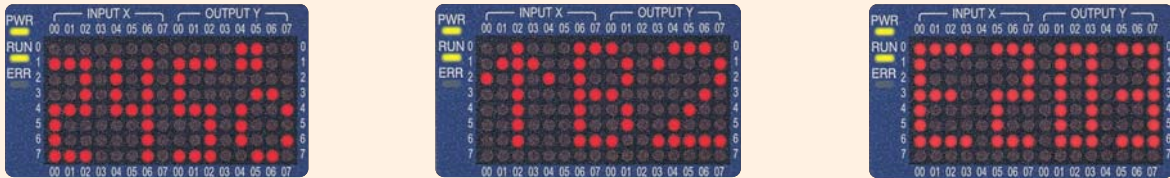

Ladder Master programming software adds simplicity to multi-functional display editing through inputting English characters, figures and symbols from a keyboard. Also, it can be used to create messages via the cursor.

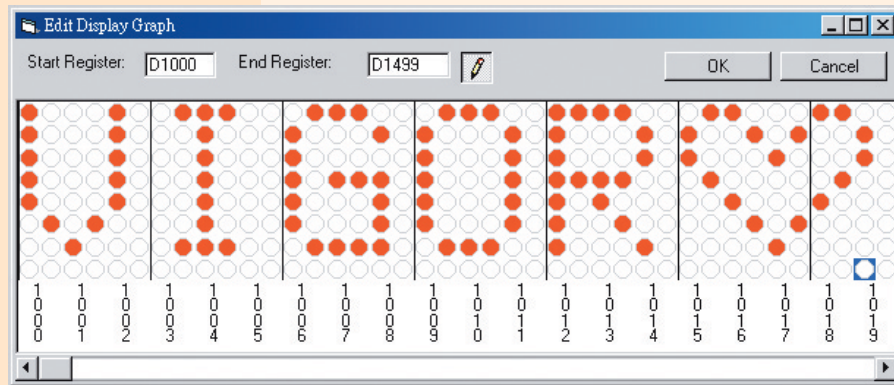

◆ Complete System Functions

- Built-in a Flash ROM program memory. The capacity size is 16K/8K steps and no back-up battery is required.
- The user program, component comments and program comments can be completely downloaded to the PLC, which is convenient for system maintenance.
- Enable the function of password protection can block program upload. It prevents unauthorized reading so the intellectual property right can be guaranteed.
- For the time-based control, it is available to install a Real Time Clock card (VB-RTC).
- The Main Unit has a built-in Multi-Functional Display, conveniently and timely displays informations.
- The integrated Auto Tuning(AT) function solves the complexity of PID control.
- MBUS instruction in combination with communication table editing function makes it easier to connect with MODBUS peripherals.
- Plenty of instructions, including: floating point, PID and compare instructions, etc.

◆ Full Communication Function

- The Main Unit has an RS-232 interface (CP1), it can be connected with a computer, HMI (Human Machine Interface) or SCADA (Supervisory Control And Data Acquisition). Also available through a MODEM to remote control, edit program and data observe.
- Multiple communication cards and expansion modules provide RS-232, RS-485 interfaces. The system can be expanded up to 19 communication ports.
- Provides various communication functions for complicated requires. e.g. Computer Link, CPU Link, Parallel Link, Easy Link, MODBUS (Master/Slave) Communication, MODEM Communication and Non-Protocol Communication.
- Provides the MODBUS (Master/Slave) communication mode, which promotes its communication capability to other peripherals.

◆ Flexible Modular Structure, With Multitudinous Models and Modules

- The Main Unit providing 14~32 I/O points optional control scales.
- The I/O expansion modules provide the control scales from 4X/4Y to 16X/16Y, fully support expansion features need.
- Two I/O connection types are available. (Barrier terminal block or ATX connector)
- Two types of power input are available. (AC 85~264V or DC 24V)
- Three output types are available. (relay, NPN or PNP transistor)
- The input point is the Sink/Source selectable connection.

◆ Numerous kinds of Special Modules Supply various Special Applications

- The analog I/O module, temperature input module, pulse output positioning module, high-speed counter module, valve controls module and communication module.

◆ Modular Structure, Flexible Combination Various of Units and Modules

◆ Compact and Ingenious Design, Saves Assembling Space.

◆ Advanced MS Windows® Based Programming Software:Ladder Master, Easy Become a Professional.

◆ Advanced PDA (Palm® OS) Based Screen Creation Software: NeoTouch, Inaugurate a New Fashion.

VB Series Main Units

Performance Specification

Item		VB0 Series	VB1 Series	VB2 Series
Operation Control Method		Cyclic Operation by Stored Program		
Programming Language Method		Electric Ladder Diagram + SFC		
I/O Control Method		Batch Processing		
Operation Processing Time	Basic Instruction	0.375~12.56 μ s		
	Applied Instruction	Server μ s ~ Server 100 μ s		
Number of Instructions	Basic Instructions	27 (including: LDP, LDF, ANDP, ANDF, ORP, ORF and INV, etc.)		
	Stepladder Instructions	2		
	Applied Instructions	133	138	133
Operation Memory Capacity	Program Capacity (Flash ROM)	Built-in 8 K Steps	Built-in 16 K Steps	Built-in 16 K Steps
	Comment Capacity	2730 words (16 words or 8 double-words for each comment)		
	Program Comment Capacity	20,000 words or 10,000 double-words		
Max. Input / Output Points		128 points: X0~X77, Y0~Y77	256 points: X0~177, Y0~Y177	512 points: X0~377, Y0~Y377
Internal Relay	Auxiliary Relay (M)	General	3120 points: M0 ~ M1999, M4000 ~ M5119	
		Latched	2000 points: M2000 ~ M3999	
		Special	256 points: M9000 ~ M9255	
	State Relay (S)	Initial	10 points: S0 ~ S9	
		General	490 points: S10 ~ S499	
		Latched	400 points: S500 ~ S899	
	Annunciator	100 points: S900 ~ S999 (Latched)		
Timer (T)		100 ms	200 points: T0 ~ T199 (Timer range: 0.1 ~ 3276.7 sec.)	
		10 ms	46 points: T200 ~ T245 (Timer range: 0.01 ~ 327.67 sec.)	
		1 ms (Retentive)	4 points: T246 ~ T249 (Timer range: 0.001 ~ 32.767 sec.)	
		100 ms (Retentive)	6 points: T250 ~ T255 (Timer range: 0.1 ~ 3276.7 sec.)	
Counter (C)	16-bit Up	General	100 points: C0 ~ C99	
		Latched	100 points: C100 ~ C199	
	32-bit Bi-directional	General	20 points: C200 ~ C219	
		Latched	15 points: C220 ~ C234	
High Speed Counter (C)	32-bit Bi-directional, Latched	1-phase Counter	11 points: C235 ~ C245 (Signal Frequency: 10 kHz Max.)	
		2-phase Counter	5 points: C246 ~ C250 (Signal Frequency: 10 kHz Max.)	
		A/B Phase Counter	5 points: C251 ~ C255 (Signal Frequency: 5 kHz Max.)	
Data Register (D)		General	7680 points: D0 ~ D6999, D7512 ~ D8191	
		Latched	512 points: D7000 ~ D7511	
		File Register	7000 points: D1000 ~ D7999	
		Special	256 points: D9000 ~ D9255	
		Index	16 points: V0 ~ V7, Z0 ~ Z7	
Pointer		Call Pointer (P)	256 points: P0 ~ P255	
		Interrupt Pointer (I)	15 points: 6 points for external interrupt, 3 points for timer interrupt, and 6 points for counter interrupt	
		Nest Pointer (N)	8 points: N0 ~ N7	
Range of Constants	Decimal (K)	16 Bits	-32768 ~ 32767	
		32 Bits	-2147483648 ~ 2147483647	
	Hexadecimal (H)	16 Bits	0H ~ FFFFH	
		32 Bits	0H ~ FFFFFFFFH	
Hardware 32-bit Bi-directional High Speed Counter		—	2 channels; Max. 200 kHz	—
Pulse Output		2 points; Max. 7 kHz	2 points; 20 kHz & 2 points; 200 kHz	2 points; Max. 7 kHz
Programming Device Link Interface		RS-232C		
Communication Link Interface (Optional)		RS-232C or RS-422 / RS-485		
Real Time Clock (Optional)		To indicates year, month, day, hour, min., sec. and week		
The Number of Special Modules Limited		4 Special Modules Max.	8 Special Modules Max.	16 Special Modules Max.
Multi-Functional Displayer		128 points (16 X 8 LED) displayer for I/O status and information		
Analog Potentiometers		2 Analog Rotary Potentiometers, each one can be setting as 0~255		

Basic Instruction Table

Title	Function	Devices
LD	LoaD	X, Y, M, S, T, C
LDI	LoaD Inverse	X, Y, M, S, T, C
AND	AND	X, Y, M, S, T, C
ANI	ANd Inverse	X, Y, M, S, T, C
OR	OR	X, Y, M, S, T, C
ORI	OR Inverse	X, Y, M, S, T, C
ANB	ANd Block	—
ORB	OR Block	—
OUT	OUT	Y, M, S, T, C
SET	SET	Y, M, S
RST	ReSeT	Y, M, S, T, C, D

Title	Function	Devices
PLS	PuLSe	Y, M
PLF	PuLse Falling	Y, M
LDP	LoaD Pulse	X, Y, M, S, T, C
LDF	LoaD Falling pulse	X, Y, M, S, T, C
ANDP	AND Pulse	X, Y, M, S, T, C
ANDF	AND Falling pulse	X, Y, M, S, T, C
ORP	OR Pulse	X, Y, M, S, T, C
ORF	OR Falling pulse	X, Y, M, S, T, C
INV	INVerse	—
MC	Master Control	N0 ~ N7
MCR	Master Control Reset	N0 ~ N7

Title	Function	Devices
MPS	Point Store	—
MRD	ReaD	—
MPP	PoP	—
NOP	No OPeration	—
END	END	—

Step Ladder Instruction Table

Title	Function	Devices
STL	STep Ladder	S
RET	RETurning to standard ladder	—

Applied Instruction Table

Type	FNC No.	Title *		Function
		D	P	
Program Flow	00	CJ	P	Conditional Jump
	01	CALL	P	CALL subroutine
	02	SRET		Subroutine RETurn
	03	IRET		Interrupt RETurn
	04	EI		Enable Interrupt
	05	DI		Disable Interrupt
	06	FEND		First END
	07	WDT	P	Watch Dog Timer refresh
	08	FOR		Start of a FOR-NEXT loop
09	NEXT		End of a FOR-NEXT loop	
Compare and Move	10	D CMP	P	CoMPare
	11	D ZCP	P	Zone ComPare
	12	D MOV	P	Move
	13	SMOV	P	Shift MOVE
	14	D CML	P	CoMPliMent
	15	BMOV	P	Block MOVE n → n
	16	D FMOV	P	Fill MOVE 1 → n
	17	D XCH	P	EXCHange
	18	D BCD	P	Converts BIN → BCD
19	D BIN	P	Converts BCD → BIN	
Arithmetic and Logical Operations	20	D ADD	P	ADDition
	21	D SUB	P	SUBtraction
	22	D MUL	P	MULTiplication
	23	D DIV	P	DIVision
	24	D INC	P	INCrement
	25	D DEC	P	DECrement
	26	D WAND	P	Logic Word AND
	27	D WOR	P	Logic Word OR
	28	D WXOR	P	Logic Word eXclusive OR
29	D NEG	P	NEGation	
Rotary and Shift	30	D ROR	P	ROtation Right
	31	D ROL	P	ROtation Left
	32	D RCR	P	Rotation Right with Carry
	33	D RCL	P	Rotation Left with Carry
	34	SFTR	P	Bit ShiFT Right
	35	SFTL	P	Bit ShiFT Left
	36	WSFR	P	Word ShiFT Right
	37	WSFL	P	Word ShiFT Left
	38	SFWR	P	ShiFT register WRite (FIFO)
39	SFRD	P	ShiFT register ReaD (FIFO)	
Data Operation	40	ZRST	P	Zone ReSeT
	41	DECO	P	DECOde
	42	ENCO	P	ENCOde
	43	D SUM	P	SUM of active bits
	44	D BON	P	CHeck specified Bit is ON
	45	D MEAN	P	MEAN
	46	ANS		Timed ANnunciator Set
	47	ANR	P	ANnunciator Reset
	48	D SQR	P	SQuare Root
	49	D FLT	P	BIN FLoaTing point format

Type	FNC No.	Title *		Function
		D	P	
High-speed Processing	50	REF	P	REFresh I/O
	51	REFF	P	REFresh I/O and Filter adjust
	52	MTR		MaTRix input
	53	D HSCS		High Speed Counter Set
	54	D HSCR		High Speed Counter Reset
	55	D HSZ		High Speed counter Zone compare
	56	SPD		SPEed Detection
	57	D PLSY		PuLSe Y output
	58	PWM		Pulse Width Modulation
Handy Instruction	59	D PLSR		PuLSe Ramp output
	61	D SER	P	SEaRch
	62	D ABSD		ABSolute Drum sequencer
	63	INCD		INCremental Drum sequencer
	64	TTMR		Teaching TiMEr
	65	STMR		Special TiMEr
	66	ALT	P	ALTerNate state
	67	RAMP		RAMP variable value
	69	SORT		SORT data
External Setting and Display	70	D TKY		Ten KeY input
	71	D HKY		Hexadecimal KeY input
	72	DSW		Digital SWitch (Thumbwheel input)
	73	SEGD	P	Seven SEGment Decoder
	74	SEGL		Seven SEGment with Latch
	76	ASC		ASCII code Conversion
	77	PR		PRint ASCII code
	78	D FROM	P	Read buffer FROM a special unit
	79	D TO	P	Write buffer TO a special unit
External Serial Communication	80	RS		RS communications
	81	D PRUN	P	Parallel RUN
	82	ASCII	P	Converts HEX → ASCII
	83	HEX	P	Converts ASCII → HEX
	84	CCD	P	CHeck CoDe
	85	VRRD	P	VR volume ReaD
	86	VRSC	P	VR volume SCale
	88	PID		PID control loop
	89	LINK		Easy LINK communication
	149	MBUS		MODBUS communication
Floating Point Operation	110	D ECMP	P	Float CoMPare
	111	D EZCP	P	Float Zone ComPare
	118	D EBDC	P	Float format BIN → EC
	119	D EBIN	P	Float format DEC → IN
	120	D EADD	P	Float ADD
121	D ESub	P	Float SUBtract	
122	D EMUL	P	Float MULtiplication	

Type	FNC No.	Title *		Function	
		D	P		
Floating Point Operation	123	D EDIV	P	Float Division	
	127	D ESQR	P	Float SQuaRe root	
	129	D INT	P	BIN float → INTEger	
	130	D SIN	P	SINe	
	131	D COS	P	COSine	
	132	D TAN	P	TANgent	
	Other	90	DBRD	P	ReaDs from the Data Bank
		91	DBWR	P	ReWRites the Data Bank
147		D SWAP	P	SWAPs high/low byte	
169		D HOUR		Operational Hour meter	
176		TFT		Timer (10 ms)	
177		TFH		Timer (100 ms)	
178		TFK		Timer (1 sec.)	
Positioning Control		155	D ABS		ABSolute current value read
	156	D ZRN		Zero ReturN	
	157	D PLSV		PuLSe V	
	158	D DRVI		DRiVe to Increment	
	159	D DRVA		DRiVe to Absolute	
	Time & Convert	160	TCMP	P	Times CoMPare
		161	TZCP	P	Time Zones ComPare
		162	TADD	P	Times ADD
		163	TSUB	P	Times SUBtract
166		TRD	P	Time ReaDs from RTC	
167		TWR	P	Time WRites to RTC	
170		D GRY	P	BIN → GRaY code	
171		D GBIN	P	Gray code → BIN	
224		D LD =		LoaD when (S1)=(S2)	
225		D LD >		LoaD when (S1)>(S2)	
In-line Comparisons	226	D LD <		LoaD when (S1)<(S2)	
	228	D LD <>		LoaD when (S1)≠(S2)	
	229	D LD ≤		LoaD when (S1)≤(S2)	
	230	D LD ≥		LoaD when (S1)≥(S2)	
	232	D AND =		AND when (S1)=(S2)	
	233	D AND >		AND when (S1)>(S2)	
	234	D AND <		AND when (S1)<(S2)	
	236	D AND <>		AND when (S1)≠(S2)	
	237	D AND ≤		AND when (S1)≤(S2)	
	238	D AND ≥		AND when (S1)≥(S2)	
	240	D OR =		OR when (S1)=(S2)	
	241	D OR >		OR when (S1)>(S2)	
242	D OR <		OR when (S1)<(S2)		
244	D OR <>		OR when (S1)≠(S2)		
245	D OR ≤		OR when (S1)≤(S2)		
246	D OR ≥		OR when (S1)≥(S2)		

* D: 32 bit operation P: Pulse (single) operation.

Regulation Specification

Item	Specification
Work Ambient Temperature	0~55° C / 32~131° F
Storage Ambient Temperature	-20~70° C / -4~158° F
Work Ambient Humidity	10~90% RH, (at 25° C / 77° F, no condensation)
Storage Ambient Humidity	10~90% RH, (at 25° C / 77° F, no condensation)
Vibration Tolerance	10 ~ 55 Hz with amplitude of 0.075mm / 0.30 inch; acceleration at 55 ~ 150 Hz = 1G; 80 min. (8 min./Cycle × 10 times = 80 min.) in each of X, Y and Z axes
Shock Tolerance	10 G, three times for each of X, Y and Z axes
Noise Immunity	Noise Simulator: 1500 Vp-p; Pulse Width: 1 μs, Frequency: 25~60Hz
Dielectric Strength	AC 1500V, 1 min. (between AC terminal and rack panel) / AC 500V, 1 min. (between DC terminal and rack panel)
Insulation Resistance	5 MΩ or above at DC 500V (between AC terminal and rack panel)
Grounding	Class-3 Grounding
Atmosphere	Keep away from corrosive gas and dusty environment

Power Specification (Including All VB Series Main Units and Expansion Units)

Item	AC Power	DC Power
Input Voltage	AC 100~240V, +10%/-15%	DC 24V, +20%/-15%
Input Frequency	50/60 Hz	--
Max. allowable momentary power failure period	Within 10 ms.	Within 1 ms.
Power Fuse	250V 2A	250V 5A
Power Consumption	30VA	12W
Power Unit Output Current	Inner	DC 5V; 400mA
		DC 12V; 530mA
	output	DC 24V, ±15%; 420mA; from terminal

◆ Notes for Expansions

- All of the VB Series Main Unit will occupy the I/O address X0~X17/Y0~Y17, thus the I/O address of the Expansion Unit/Module will start from X20/Y20.
- All of the VB Series Special Modules will not occupy any I/O address.
- The VB-8XY expansion module will occupy 8 input points and 8 output points.

• The available I/O points:

VB0 Series: Max. 128 points (X0~X77, Y0~Y77);
 VB1 Series: Max. 256 points (X0~X177, Y0~Y177);
 VB2 Series: Max. 512 points (X0~X377, Y0~Y377)

• The number of the Special Modules to be linked:

VB0 Series: Up to 4 Special Modules;
 VB1 Series: Up to 8 Special Modules;
 VB2 Series: Up to 16 Special Modules.

• The statement about I/O expand

The VB series PLC Main Unit and Expansion Unit contain a power supply unit, but the Expansion Module and Special Module does not have a power unit, those module needs a power source to get power (for example from a Main Unit, Expansion Unit or VB-PWR Power Expansion Unit).

The statement of available modules amount with a Main Unit, Expansion Unit or VB-PWR Power Expansion Unit:

Two important connecting limits, from a Main Unit to Expansion Modules:

- (1) $[(\text{The amount of Expansion Modules}) + (\text{The amount of Special Modules}) \times 2] \leq 4$
- (2) All equipments using power form the Main Unit (including itself and Expansion Modules), the output points:
 $[(\text{The amount of "ON" status relays}) \times 6 + (\text{The amount of "ON" status trans transistors})] \leq 192$

Two important connecting limits, from a VB-PWR Power Expansion Unit to Expansion Modules:

- (1) $[(\text{The amount of Expansion Modules}) + (\text{The amount of Special Modules}) \times 2] \leq 12$
- (2) All equipments using power form the VB-PWR Power Expansion Unit, the output points:
 $[(\text{The amount of "ON" status relays}) \times 6 + (\text{The amount of "ON" status trans transistors})] \leq 288$

Two important connecting limits, from an Expansion Unit to Expansion Modules:

- (1) $[(\text{The amount of Expansion Modules}) + (\text{The amount of Special Modules}) \times 2] \leq 12$
- (2) All equipments using power form the Expansion Unit (including itself and Expansion Modules), the output points:
 $[(\text{The amount of "ON" status relays}) \times 6 + (\text{The amount of "ON" status trans transistors})] \leq 192$

Input Point Specification

Item	Specification	
Input Activating Voltage	DC 24V ± 15%	
Input Signal Circuit	7 mA / DC 24V	
Input ON Circuit	Above 3.5 mA	
Input OFF Circuit	Below 1.7 mA	
Input Resistance	3.3 kΩ approximately	
Input Response Time	10 ms approximately (X0~X7 are variable, can be set between 0~60 ms.)	
Input Signal Type	Dry Contact or NPN/PNP open collector transistor	
Isolation Mode	Photocoupler Isolation	
Circuit Diagram	<div style="display: flex; justify-content: space-around;"> <div style="text-align: center;"> <p>AC Power Model</p> </div> <div style="text-align: center;"> <p>AC Power Model</p> </div> <div style="text-align: center;"> <p>DC Power Model</p> </div> <div style="text-align: center;"> <p>DC Power Model</p> </div> </div>	
		<div style="display: flex; justify-content: space-around;"> <div style="text-align: center;"> <p>AC Power Model</p> </div> <div style="text-align: center;"> <p>AC Power Model</p> </div> <div style="text-align: center;"> <p>DC Power Model</p> </div> <div style="text-align: center;"> <p>DC Power Model</p> </div> </div>
		<div style="display: flex; justify-content: space-around;"> <div style="text-align: center;"> <p>AC Power Model</p> </div> <div style="text-align: center;"> <p>AC Power Model</p> </div> <div style="text-align: center;"> <p>DC Power Model</p> </div> <div style="text-align: center;"> <p>DC Power Model</p> </div> </div>
		<div style="display: flex; justify-content: space-around;"> <div style="text-align: center;"> <p>AC Power Model</p> </div> <div style="text-align: center;"> <p>AC Power Model</p> </div> <div style="text-align: center;"> <p>DC Power Model</p> </div> <div style="text-align: center;"> <p>DC Power Model</p> </div> </div>

Output Point Specification

Item	Specification		
Output Type	Relay Output	NPN Transistor Output	PNP Transistor Output
Switched Voltages	≦ AC 250V / DC 30V	DC 5V ~ 30V	DC 5V ~ 30V
Rated Current	Resistive Load	2 A / point, 8 A / 4 points/COM	0.5 A / point, 0.8 A / 4 points/COM
	Inductive Load	80VA	12W / DC 24V
	Lamp Load	100W	1.5W / DC 24V
Open Circuit Leakage	—	< 0.1mA	< 0.1mA
Response Time	10 ms approximately	OFF→ON: < 20 μs ON→OFF: < 100 μs	OFF→ON: < 20 μs ON→OFF: < 100 μs
Isolation Method	Mechanic Isolation (Relay)	Photocoupler Isolation	Photocoupler Isolation
Circuit Diagram			

Formation of Communication System

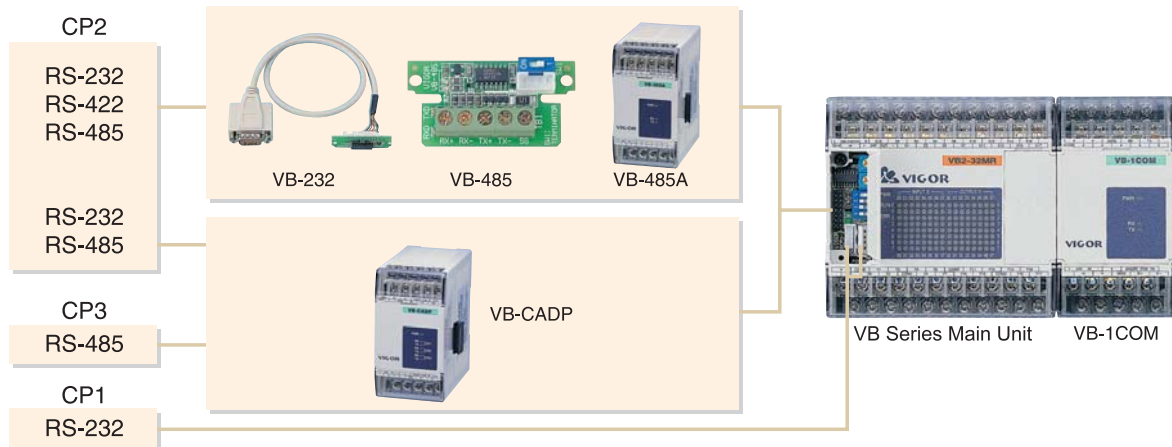

◆ COM Port 1 (CP1) :

The CP1 is a built-in RS-232 communication standard interface. It is available to connect with other equipment via either the USB-A type or the white JST 4P connector.

The applicable communication type of CP1 is the Computer Link, which is used to execute the M, VB and VH Series communication protocol. Its main purposes are to:

1. Connect to the programming tools (Computer + Ladder Master or PDA + NeoTouch).
2. Connect to the HMI (Human-Machine Interface) or SCADA (Supervisor Control And Data Acquisition).
3. Connect with a MODEM, which is for remote program modification and data monitoring.

◆ COM Port 2 (CP2) :

CP2 is a multi-functional expansion communication port and it can be used for various communication applications.

1. **Computer Link** – Uses the M, VB and VH Series communication protocol and it has the same purpose for use as CP1 in the RS-232 interface. By the RS-485 interface, a computer and several PLCs can constitute a monitoring local access network.
2. **CPU Link** – Uses the dedicated communication protocol and it is only available by the RS-485 interface. The CPU Link allows data transfer between (2~8) PLCs, usually it is used for the distributed control system.
3. **Parallel Link** – Uses the dedicated communication protocol and it has almost the same purpose as the CPU Link, except its procedure is simpler and it only allows data to be transferred between 2 PLCs.
4. **Easy Link** – Uses the M, VB and VH Series communication protocol. Basically this application type is similar to the Computer Link, except this Easy Link uses a Main Unit of M or VB Series (which is called "Master PLC") to replace the computer, HMI or SCADA in the local network. For the data transfer in the network, programmer need to put the LINK instruction (FNC 89) in the Master PLC's program to access the data in Slave PLCs.
5. **MODBUS** – Uses the MODBUS (Master/Slave) communication protocol (the MODBUS is a standard open source communication protocol). Usually all the SCADA (Supervisor Control And Data Acquisition) and HMI (Human-Machine Interfaces) have the MODBUS communication protocol. So, if a device without the M, VB and VH Series communication protocol, it can link to the VB and VH Series PLC's via the MODBUS.
6. **MODEM Communication** – Actively contacts with a MODEM when the PLC boots up (MODEM's "AA" sign should light on), then exercises M, VB and VH Series communication protocol. By the linked MODEMs, the PLC allows the user to perform remote program modification or data monitoring.
7. **MODEM Dialing** – Uses the function of MODEM Communication described above (if the dialing function of VB Series PLC and MODEM are activated) and then triggers the PLC's Dial-up Connection to link with the other PLC. The function is very useful, especially for remote abnormality report, security system and data collector.
8. **Non Protocol** – It does not administer any specific communication protocol. All communication processes are customized and completed by PLC program. It uses RS instruction (FNC80) to receive and transfer communication operation. This communication type is usually used for links with other peripherals on the market, such as temperature controller, frequency converter, display, printer, card reader or bar code reader.

◆ COM Port3 (CP3) :

The CP3 is a RS-485 communication port which is expanded by the VB-CADP expansion module and the communication type is assigned as Computer Link (using the M,VB and VH Series communication protocol). It is usually linked with the HMI (Human-Machine Interface) or the SCADA (Supervisor Control And Data Acquisition) to make the monitoring of local networking.

◆ VB-1COM :

The VB Series PLC Serial Link Communication Module provides a RS-232/RS-485 communication port. It does not administer any specific communication protocol. All the communication processes are customized and completed by the PLC program. This module is usually used to communicate with other peripherals, such as commercially available temperature controller, frequency converter or bar code reader. A Main Unit can be connected with up to 16 VB-1COM modules.

Communication Expansion Card



VB-232



The RS-232 Communication Expansion Card



VB-485

The RS-485 Communication Expansion Card

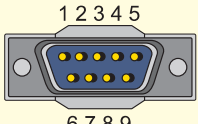
- The VB-232 and VB-485 are the Second COM Port (CP2) expansion cards of the VB Series PLC.
- The CP2 of the VB Series PLC is a multi-functional communication port that can be used for multifarious communication types, e.g. Computer Link, CPU Link, Parallel Link, Easy Link, MODBUS Communication, MODEM Communication and Non-Protocol Communication.

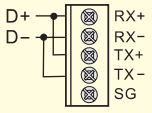
Item	VB-232	VB-485
Transmission Interface	RS-232C	RS-422/RS-485
Isolation Mode	No Isolation	
LED Indicator	RXD, TXD	
Distance	15 M (48.21') Max.	50 M (164.04') Max.
Communication Method	Half-duplex	
Baud Rate	300/600/1200/2400/4800/9600/19200/38400 bps	
Communication Protocol	Computer Link } M, VB and VH Series Easy Link } PLC communication MODEM } protocol Parallel Link : Dedicated communication protocol MODBUS : The MODICON's communication protocol User-defined. It communicates to other devices by the PLC program (RS instruction) Non Protocol :	Computer Link } M, VB and VH Series Easy Link } PLC communication protocol CPU Link } Dedicated communication Parallel Link } protocol MODBUS : The MODICON's communication protocol User-defined. It communicates to other devices by the PLC program (RS instruction) Non Protocol :
Power Require	DC 5V, 10mA (from PLC Main Unit)	DC 5V, 60mA (from PLC Main Unit)
Connection	 <p>D-Sub Connector 9-pin male</p> <p>1 : CD 2 : RXD 3 : TXD 5 : SG 7 : RTS 8 : CTS 4,6,9 : Not Use</p>	The PCB Style Terminal Block  <p>Note: 1. RS-485 Wiring:  2. SW1 is the terminal resistance switch (terminal resistance 120Ω.)</p>
Parameter Configuration Setting	For selections of CP2 application types and relevant parameter configuration settings, please use the developmental software Ladder Master and then open the option: "System - 2nd COM Port Setting....".	



VB-CADP Dual-Port Communication Expansion Module

- It is a CP2 and CP3 expansion module.
- The CP2 provides an isolated RS-232C or RS-485 communication interface. The communication distance of its RS-485 interface is up to 1000 M (3280').
- The CP3 provides isolated RS-485 communication interface with the communication distance of this RS-485 interface is up to 1000 M (3280').
- The CP2 of the VB Series PLC is a multi-functional communication port which can be assigned for various communication applications, e.g. Computer Link, CPU Link, Parallel Link, Easy Link, MODBUS Communication, MODEM Communication and Non-Protocol communication.

Item\Port	CP2		CP3
Transmission Interface	RS-232C	RS-485	RS-485
Isolation Mode	Photocoupler Isolation		
LED Indicator	RX, TX		RX, TX
Distance	15 M (48.21') Max.	1000 M (3280') Max.	1000 M (3280') Max.
Communication Method	Half-duplex		
Baud Rate	300/600/1200/2400/4800/9600/19200/38400 bps		19200 bps
Communication Protocol	Computer Link } M, VB and VH Series PLC communication protocol Easy Link } MODEM(RS-232) } CPU Link(RS-485) } Dedicated communication protocol Parallel Link } MODBUS : The MODICON's communication protocol User-defined. Non Protocol : It communicates to other devices by the PLC program (RS instruction).		Computer Link : M, VB and VH Series PLC communication protocol Data Length : 7 bit (ASCII) Parity : EVEN Stop bit : 1 bit
Power Require	DC 24V ± 10%, 70mA (External power required)		
Connection	Barrier style terminal block connection 		
Parameter Configuration Setting	For selection of CP2 application types and relevant parameter configuration settings, please use the developmental software Ladder Master, then open the option: "System - 2nd COM Port Setting....".		Communication station number setting is by the rotary switch on the left side of the module. (00~99)

- ◆ After linking VB-CADP Module, the Main Unit's CP1 will be disabled, and its function will be replaced by VB-CADP's CP1.
- ◆ VB-CADP Module provides RX, TX indicator lamps of PWR and CP1.



VB-485A RS-485 Communication Expansion Module

- The Second COM Port (CP2) expansion module for a Main Unit.
- It is an isolated RS-485 communication interface, the distance is up to 1000 M (3280').
- The CP2 of the VB Series PLC is a multi-functional communication port that can be assigned for various communication applications, e.g. Computer Link, CPU Link, Parallel Link, Easy Link, MODBUS Communication, MODEM Communication and Non-Protocol Communication.

Item	Specification
Transmission Interface	RS-485
Isolation Method	Photocoupler Isolation
LED Indicator	PWR, RX, TX
Distance	1000 M (3280') Max.
Communication Method	Half-duplex
Baud Rate	300/600/1200/2400/4800/9600/19200/38400 bps
Communication Protocol	Computer Link } M , VB and VH Series PLC communication protocol Easy Link } CPU Link } Dedicated communication protocol Parallel Link } MODBUS : The MODICON's communication protocol Non Protocol : User-defined. It communicates to other devices by the PLC program (RS instruction).
Power Require	DC 24V \pm 10% , 55mA (External power required)
Connection	Barrier style terminal block connection
Parameter Configuration Setting	For selection of CP2 application types and relevant parameter configuration settings, please use the developmental software Ladder Master, then open the option: "System - 2nd COM Port Setting...." .



VB-1COM Serial Link Communication Module

- The VB-1COM is a VB Series special module.
- The VB-1COM can be used for either RS-232 or RS-485 interface.
- Both the RS-232 and RS-485 interfaces are isolated. The communication distance of its RS-485 interface is up to 1000 M (3280').
- The module has the HEX and ASCII codes auto conversion function for the data receive/transfer.
- A Main Unit can be connected with up to 16 VB-1COM modules.

Item	Specification	
Transmission Interface	RS-232	RS-485
Isolation Method	Photocoupler Isolation	
LED Indicator	PWR, RX, TX	
Distance	15 M (48.21') Max.	1000 M (3280') Max.
Communication Method	Half-duplex	
Baud Rate	300/600/1200/2400/4800/9600/19200/38400/76800/14400/28800/57600 bps	
Communication Protocol	Non-Protocol: User-defined. It communicates to other devices by the PLC program.	
Communication Format	Designated by the BFM (BuFfer Memory) from the user program (9 formats available)	
Communication with PLC	Using FROM/TO instructions via BFM	
Power Require	DC 24V \pm 10% , 45mA (External power required); DC 5V, 75mA (from PLC Main Unit)	
Connection	Barrier style terminal block connection	

Communication Operation Modes

The VB Series PLC have complete communication functions. It provides several communication operation modes, which can be used for various applications. (such as local network monitoring, dispersive control, links to peripherals, MODEM communication, etc.) The following are the communication operation modes of the VB Series.

◆ Computer Link

● A computer, HMI (Human-Machine Interface) or SCADA (Supervisor Control And Data Acquisition) can connect to PLCs via the Computer Link. It uses the M, VB and VH Series communication protocol.

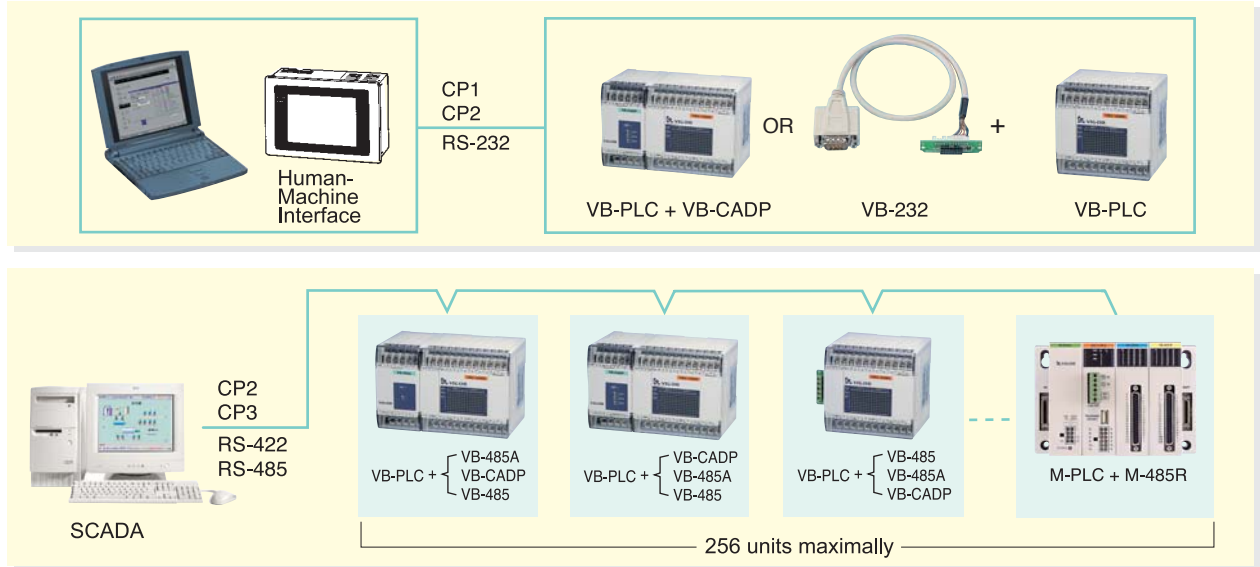

Item	Specification	
Transmission Interface	RS-232	RS-422/RS-485
Communication Protocol	M, VB and VH Series Communication Protocol	
Communication Method	Half-duplex	
Communication Parameter	Data Length: 7 bits (ASCII)	Parity: EVEN Stop Bit: 1 bit
Baud Rate	CP1 and CP3: 19200 bps	CP2: 4800/9600/19200/38400 bps
Distance	15 M (49')	1000 M (3280'); (50 M /164' if the network has a VB-485)
Number of Link Stations	1 station	256 stations maximum (when more than 32 stations, a powered booster is required)
Connection Equipment	CP2: VB-232 or VB-CADP CP3: VB-CADP; M Series: M-485R	CP1: Main Unit Built-in CP2: VB-485, VB-485A or VB-CADP
Linkable PLC	VB Series, VH Series and M Series PLC	
Data Transfer Range	Including all of X, Y, M, S, T, C and D	

◆ Easy Link

● PLC uses the CP2 via the M, VB and VH Series communication protocol, by the program of Master (a M or VB series) PLC to control the data transfer between PLCs.

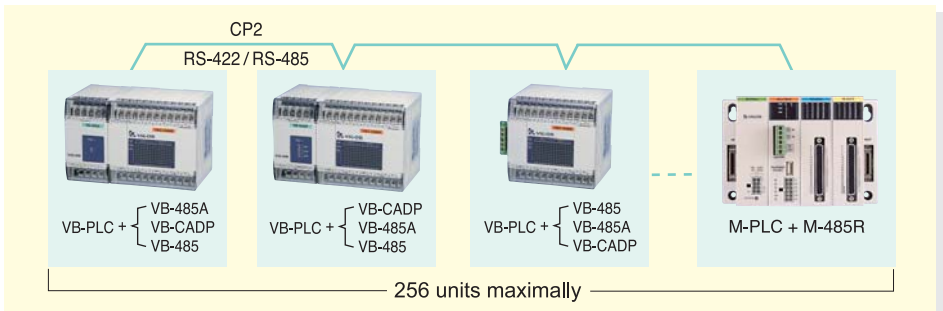

Item	Specification	
Transmission Interface	RS-422/RS-485	
Communication Protocol	M, VB and VH Series Communication Protocol	
Communication Method	Half-duplex	
Communication Parameter	Data Length: 7 bits (ASCII)	Parity: EVEN Stop Bit: 1 bit
Baud Rate	4800/9600/19200/38400 bps	
Distance	1000 M (3280'); (50 M /164', if the network has a VB-485)	
Number of Link Stations	256 stations max. (when more than 32 stations, a powered booster is required)	
Connection Equipment	VB or VH Series: VB-485, VB-485A or VB-CADP; M Series: M-485R	
Linkable PLC	VB Series and M Series PLC (VH Series can be used as a Slave)	
Data Transfer Range	Including all of X, Y, M, S, T, C and D	

◆ Parallel Link

- By this configuration setting, two PLCs use the dedicated communication protocol to transfer specific data automatically.

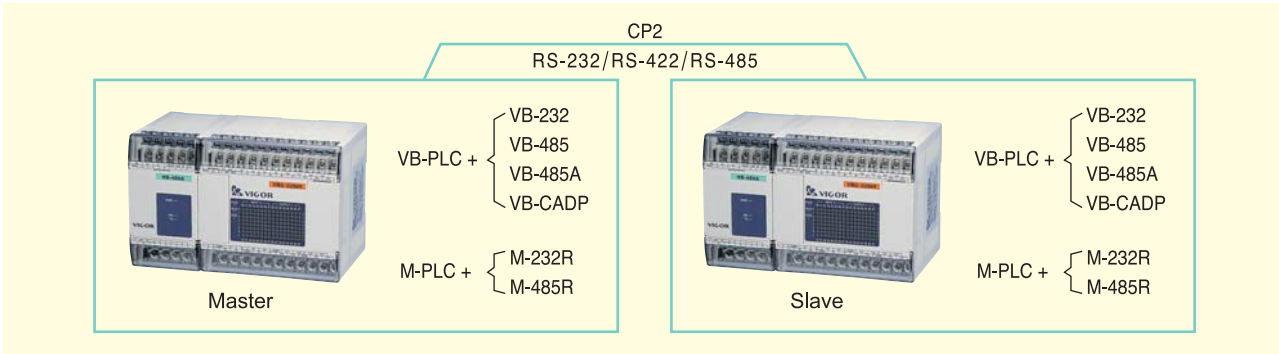

Item		Specification	
Transmission Interface	RS-232	RS-422/RS-485	
Communication Protocol	Dedicated Communication Protocol		
Communication Method	Half-duplex		
Baud Rate	4800/9600/19200/38400 bps		
Distance	15 M (49')	1000 M (3280'); (50 M /164', if the network has a VB-485)	
Number of Link Stations	2 stations		
Connection Equipment	VB Series: VB-232 or VB-CADP M Series: M-232R	VB Series: VB-485, VB-485A or VB-CADP M Series: M-485R	
Linkable PLC	VB Series and M Series PLC		
Transferable Data	Low Speed	Master→Slave: M800~899, D490~499; Slave→Master: M900~999, D500~509	
	High Speed	Master→Slave: D490 and D491; Slave→Master: D500 and D501	
Communication Time	Low Speed	Master's Scan Time + Slave's Scan Time + 73ms (when the Baud Rate = 19200 bps)	
	High Speed	Master's Scan Time + Slave's Scan Time + 14ms (when the Baud Rate = 19200 bps)	

◆ CPU Link

- PLC will enable dedicated communication protocol, and PLCs in the network will transfer data automatically depending on configuration settings.

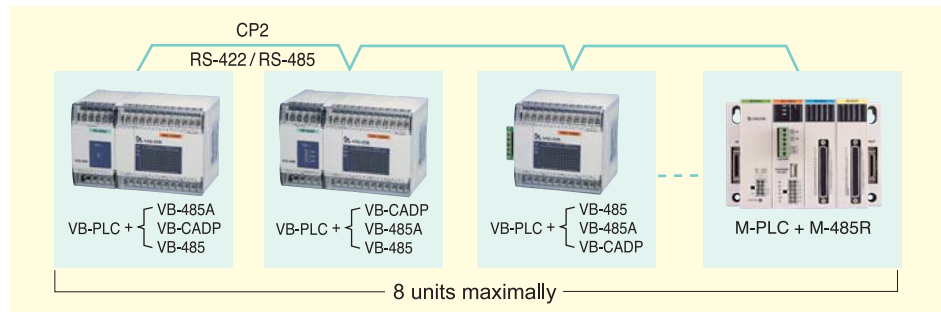

Item		Specification							
Transmission Interface	RS-422/RS-485								
Communication Protocol	Dedicated Communication Protocol								
Communication Method	Half-duplex								
Baud Rate	38400 bps								
Distance	1000 M (3280'); (50 M /164', if the network has a VB-485)								
Number of Link Stations	2~8 stations								
Connection Equipment	VB Series: VB-485, VB-485A or VB-CADP; M Series: M-485R								
Linkable PLC	VB Series and M Series PLC								
Transferable Data	Station No.	0 (Master)	1 (Slave)	2 (Slave)	3 (Slave)	4 (Slave)	5 (Slave)	6 (Slave)	7 (Slave)
	Mode 1	D0~3	D10~13	D20~23	D30~33	D40~43	D50~53	D60~63	D70~73
	Mode 2	D0~3 M1000~1031	D10~13 M1064~1095	D20~23 M1128~1159	D30~33 M1192~1223	D40~43 M1256~1287	D50~53 M1320~1351	D60~63 M1384~1415	D70~73 M1448~1479
	Mode 3	D0~7 M1000~1063	D10~17 M1064~1127	D20~27 M1128~1191	D30~37 M1192~1255	D40~47 M1256~1391	D50~57 M1320~1383	D60~67 M1384~1447	D70~77 M1448~1511

◆ CPU Link Communication Time:

Number of Linked Stations	2 Stations	3 Stations	4 Stations	5 Stations	6 Stations	7 Stations	8 Stations
Mode 1	7mS	11mS	15mS	19mS	23mS	27mS	31mS
Mode 2	10mS	15mS	20mS	25mS	30mS	35mS	40mS
Mode 3	16mS	24mS	33mS	42mS	50mS	59mS	68mS

Communication Operation Modes

VB SERIES PROGRAMMABLE CONTROLLER

◆ MODBUS Communication

• Communication between PLC and Computer, HMI (Human-machine Interface), SCADA (Supervisor Control And Data Acquisition) and other devices, via the MODBUS communication protocol.

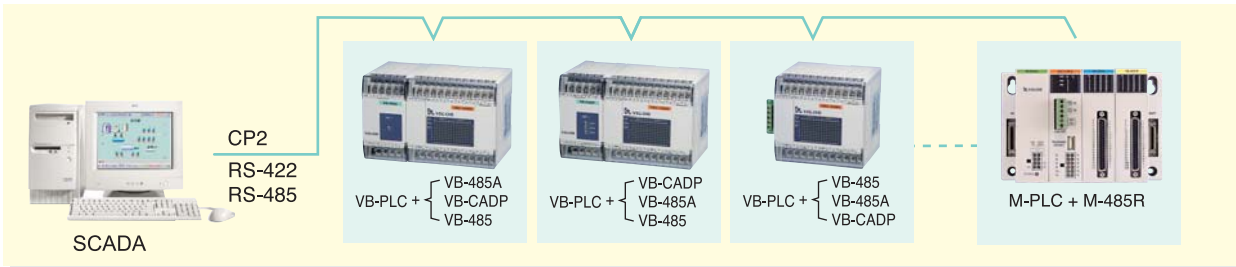

Component Convert Table Between VB-PLC and MODBUS

Item	Specification	
Transmission Interface	RS-232	RS-422/ RS-485
Communication Method	Half-duplex	
Communication Parameter	Communication Mode: ASCII or RTU Data Length: 7 bits / 8 bits Parity: None / Odd / Even Stop Bit: 1 bit / 2 bits	
Baud Rate	300/600/1200/2400/4800/9600/19200/38400 bps	
Distance	15 M (49')	1000M (3280'); (50M /164', if the network has a VB-485)
Number of Link Stations	2 stations	Up to 247 Stations
Connection Equipment	VB-232 or VB-CADP	VB-485, VB-485A or VB-CADP M Series: M-485R
Linkable PLC	VB Series, VH Series and M Series PLC	

Assign Numbers of Bit Components	
VB-PLC Component	MODBUS Component
X000~X177	10000~10127
Y000~Y177	00000~00127
M0~M5119	00512~05631
S0~S999	05632~06631
T0~T255	06656~06911
C0~C255	06912~07167
M9000~M9255	07424~07679

Assign Numbers of Character Components	
VB-PLC Component	MODBUS Component
D0~D8191	40000~48191
T0~T255	48192~48447
C0~C199	48448~48647
C200~C255	48648~48759
D9000~D9255	48760~49015

• PLC can communicate with MODBUS enabled devices using MODBUS communication protocol.

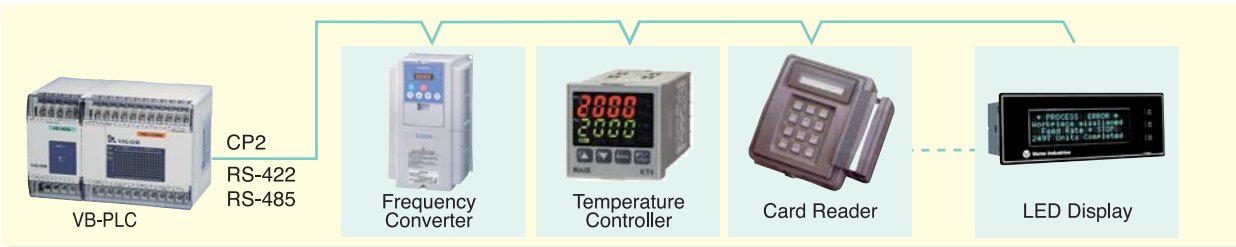

◆ MODEM Communication

This communication mode is implemented by the M and VB, VH Series communication protocol. When a computer using this mode through the telephone system, it allows to telecommute monitor a PLC, and it also can do the system maintenance or data collection.

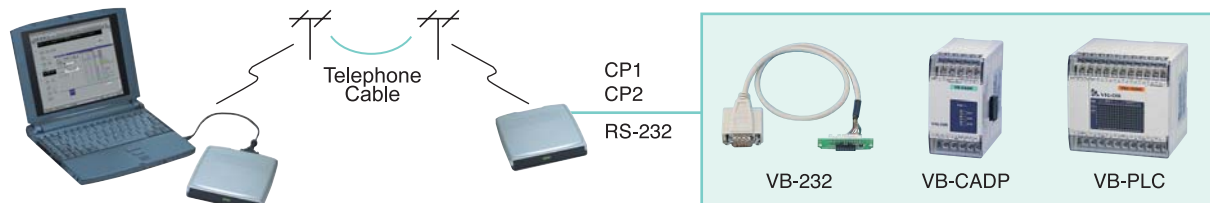

◆ MODEM Dialing

• M and VB, VH Series PLC have specific Registers to memorize the telephone numbers, which can be used for the MODEM Dialing function. The on-site PLCs through this MODEM Dialing function, will transfer data automatically to the monitoring center;s M and VB, VH series PLC for data collection. Also, they can dial-up a pager or cellular phone for caller ID display.

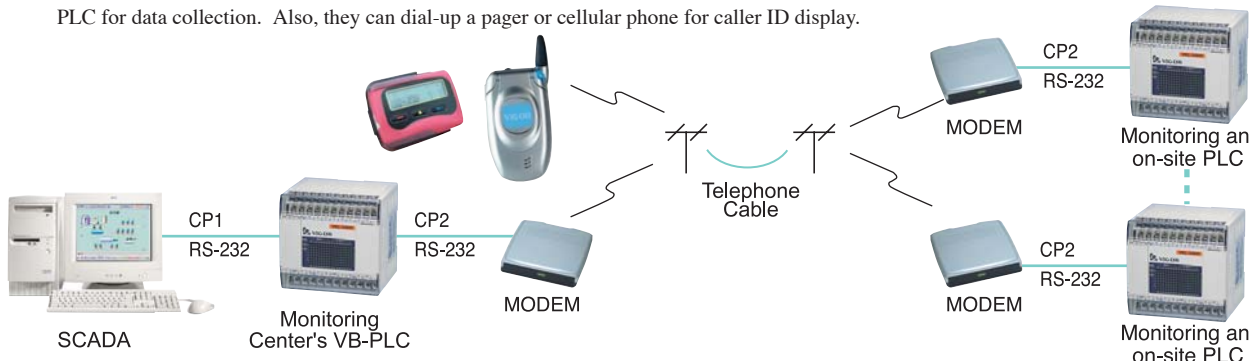

Considerate Design Remarkable Innovation

◆ Non-Protocol Communication

- M、VH and VB series PLC can use this Non-Protocol Communication function, it does not administer any specific communication protocol. All communication processes are customized and completed by PLC program, which is for connection with various equipment does not have the standard protocol.

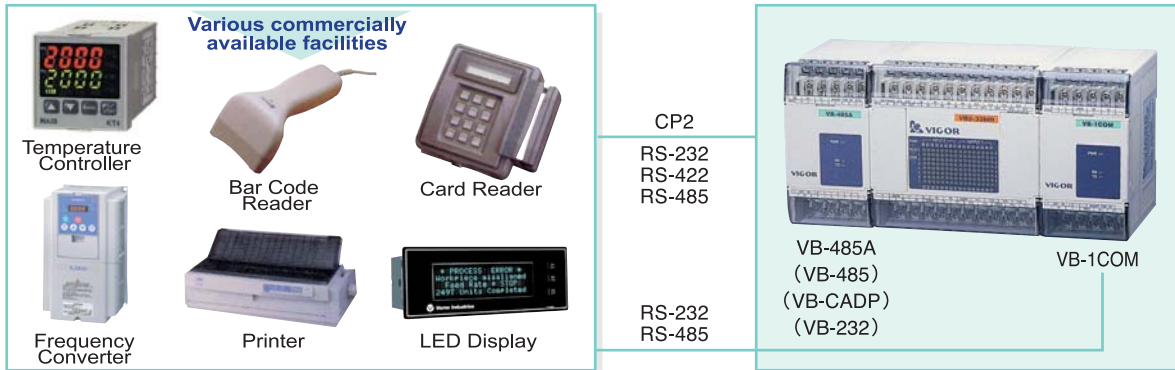

CP 2 Non-Protocol Communication Specification

Item	Specification	
Transmission Interface	RS-232	RS-422/ RS-485
Communication Protocol	Non-Protocol	
Communication Method	Half-duplex	
Communication Parameter (Please use the option "System - 2nd COM Port Setting..." of the developmental software Ladder Master.)	Baud Rate	300/600/1200/2400/4800/9600/19200 bps
	Data Length	7 bits / 8 bits
	Parity	None / Odd / Even
	Stop Bit	1 bit / 2 bits
	Initiation Code	None or arbitrary data
	Termination Code	None or arbitrary data
Distance (refer to connected peripherals)	Up to 15 M (49')	Up to 1000 M (3280'); (50 M /164', if the network has a VB-485)
Connection Facility	VB-232 or VB-CADP	VB-485, VB-485A or VB-CADP
Linkable PLC	VB Series, VH Series and M Series PLC	

VB-1COM Communication Specification

Item	Specification	
Transmission Interface	RS-232	RS-422/ RS-485
Communication Protocol	Non-Protocol	
Communication Method	Half-duplex	
Communication Parameter (Designated by the BFM from the user program)	Baud Rate	300/600/1200/2400/4800/9600/19200 bps
	Data Length	7 bits / 8 bits
	Parity	None / Odd / Even
	Stop Bit	1 bit / 2 bits
	Initiation Code	None or arbitrary data
	Termination Code	None or arbitrary data
Distance (refer to connected peripherals)	Up to 15 M (49')	Up to 1000 M (3280'); (50 M /164', if the network has a VB-485)



VB-2VC 2-Channel Valve Controls Module

- High current driving capability (up 1.05A ±5% per channel).
- Equipped with high resolution 12-bit DAC for high precision control.
- Fully digital control including MIN and MAX current, rising or falling Slope and Mode of slope.
- Provide another S-type slope mode for accelerating and decelerating automatically.
- Very wide range of adjustment of slope for each channel.
- High efficiency switching mode operation for reducing power dissipation.
- Operation by single DC power (Vs) or just only voltage on 24 (+,-) supplied for downgrade power supply cost.
- Equipped with Poly Switch (self-recovery Fuse) for downgrade the maintenance cost.

Item	Specification
Channels Supported	2
Max. Driving Current	1.05A ±5% Per Channel
Current Resolution	271µA ±5% for Both Channel
Slope Mode of Each Channel	Linear, S-type or Mixed
Voltage Applied to Valves (Vs+, 24-)	12V ~ 45V
Switching Frequency	25 kHz



VB-2DA 2-Channel, 12-Bit Analog Output Module

- 12-bit resolution provides high precision resolution.
- The voltage or current output can be specified for each channel independently.
- The gain and offset of each output channel can be adjusted independently.
- Photocoupler isolation between output analog signals and digital PLC circuits. Inner DC to DC isolated converter supplies the clean power.

Item	Specification	
Analog Output Type	Voltage Output	Current Output
Analog Output Range	0 ~ 10 V	4 ~ 20 mA
Digital Input Range	0 ~ 4000	0 ~ 4000
External Load Resistance	500 Ω ~ 1 MΩ	500 Ω or less
Resolution	2.5 mV	5 µA
Overall Accuracy Conversion Speed	±1% (Max.) / 0.4 ms (2 channels)	
Isolation Method	Photocoupler isolation between PLC and outputs; no isolation between output channels	
Power Consumption	DC 24V, ±20%; 100 mA (Max.)	



VB-4DA 4-Channel, 8-Bit Analog Output Module

- Providing 5 output modes: 0V ~ +10V; 0V ~ +5V; +1V ~ +5V; 0 mA ~ +20 mA and +4 mA ~ +20 mA
- The voltage or current output can be specified for each channel and the conversion characteristic of each output channel can be set independently.
- Photocoupler isolation between output analog signals and digital PLC circuits. Inner DC to DC isolated converter supplies the clean power.

Item	Specification				
Analog Output Type	Voltage Output			Current Output	
Analog Output Range	0V ~ +10V	0V ~ +5V	+1V ~ +5V	0 mA ~ +20 mA	+4 mA ~ +20 mA
Digital Input Range	0 ~ +250				
External Loading Resistance	500 Ω ~ 1 MΩ			500 Ω or less	
Resolution	40 mV	20 mV	16 mV	80 µA	64 µA
Overall Accuracy Conversion Speed	±1% (Max.) / 0.8 ms (4 channels)				
Isolation Method	Photocoupler isolation between PLC and outputs; no isolation between output channels				
Power Consumption	DC 24V, +20% / -15%; 120 mA (Max.)				



VB-4AD 4-Channel, 12-Bit Analog Input Module

- 12-bit resolution provides high precision resolution.
- The voltage or current input can be specified for each channel independently.
- The gain and offset of each input channel can adjust independently.
- Equipped with a 10V accurately standard voltage output, offers reference power source for the linear potentiometer
- Photocoupler isolation between input analog signals and digital PLC circuits. Inner DC to DC isolated converter supplies the clean power.

Item	Specification	
Analog Input Type	Voltage Input	Circuit Input
Analog Input Range	-10V~+10V	-20mA~+20mA/4mA~20mA
Digital Output Range	-2000~+2000	-2000~+2000/0~2000
Input Resistance	200KΩ	250Ω
Resolution	5mV	10 μA
Max. Input Range	±15V	±32mA
Overall Accuracy	±1% (Max.)	
Conversion Speed	0.5mS × (1~4) point(s)	
Isolation Method	Photocoupler isolation between PLC and inputs; no isolation between input channels	
10V Accurately Standard Voltage Output	DC 10V, ±0.5%; 60 mA (Max.)	
Power Consumption	DC 24V, ±20%; 120 mA (Max.)	



VB-6A 4-Channel, 12-Bit Analog Input / 2-Channel, 12-Bit Analog Output Module VB-3A 2-Channel, 12-Bit Analog Input / 1-Channel, 12-Bit Analog Output Module

- 12-bit resolution provides high precision resolution.
- The voltage or current input can be specified for each channel independently.
- The voltage or current output can be specified for each channel independently.
- The gain and offset of each input/output channel can be adjusted independently.
- A 10V accurately standard voltage output, offers reference power source for the linear potentiometer.
- Photocoupler isolation between analog I/O signals and digital PLC circuits. Inner DC to DC isolated converter supplies the clean power.

Analog Input Feature Specification

Item	Specification	
Analog Input Type	Voltage Input	Current Input
Analog Input Range	-10V ~ +10V	-20 mA ~ +20 mA / 4 mA ~ 20 mA
Digital Output Range	-2000 ~ +2000	-2000 ~ +2000 / 0 ~ 2000
Input Resistance	200 kΩ	250 Ω
Resolution	5 mV	10 μA
Max. Input Range	±15V	±32 mA
Overall Accuracy	±1% (Max.)	
Conversion Speed	0.5 ms × (1~4) channel(s)	

Analog Output Feature Specification

Item	Specification	
Analog Output Type	Voltage Output	Current Output
Analog Output Range	0 ~ 10 V	4 ~ 20 mA
Digital Input Range	0 ~ 4000	0 ~ 4000
External Load Resistance	500 Ω ~ 1 MΩ	500 Ω or less
Resolution	2.5 mV	5 μA
Overall Accuracy	±1% (Max.)	
Conversion Speed	VB-6A: 0.4 ms / 2 channels ; VB-3A: 0.2 ms / 1 channel	

Common Specification

Item	Specification	
10V Accurately Standard Voltage Output	DC 10V, ±0.5%; 60 mA (Max.)	
Isolation Method	Photocoupler isolation between PLC and outputs; no isolation between output channels	
Power Consumption	VB-6A	DC 24V, ±20%; 210 mA (Max.)
	VB-3A	DC 24V, ±20%; 160 mA (Max.)



VB-8T 8-Channel J/K TC Temperature Input Module
VB-4T 4-Channel J/K TC Temperature Input Module

- Each input channel can be set to J or K type thermocouple sensor input. Also it is possible to set the temperature range and resolution for each input channel independently.
- The 0.1 °C / 0.18 °F high resolution temperature detection.
- The instrument-level "Dual-Slope ADC" can give accurate and stable measurement values. Also it filters out white noise induced by 50/60Hz power line.
- The Centigrade (°C) or Fahrenheit (°F) measurement values are available.
- Providing the temperature sensors' open circuit detective function.

Item		Specification	
Analog Sensor		Up to 8 / 4 Channel Thermocouples (Type J, K or JIS 1602-1981)	
Unit Type		Centigrade (°C)	Fahrenheit (°F)
Range	K Type	-270.0 ~ +1370.0 °C	-454.0 ~ +2498.0 °F
	J Type	-210.0 ~ +1200.0 °C	-346.0 ~ +2192.0 °F
Digital Output Range		200,000 Reading	
Resolution		0.1 °C	0.18 °F
Overall Accuracy		±0.3% of full scale (compensated range)	
Conversion Speed		The period of conversion is 0.5 sec. ~ 2 sec. (According to the No. of channels is in use at the same group; CH 1~4 are a group, CH 5~8 are another group.)	
Isolation Method		1. The VB-8T / VB-4T has 2/1 group analog input circuit(s). Each group supports 4 channels thermocouple inputs and has its own isolation DC/DC power converter. 2. Photocoupler isolation between 2 analog circuit groups and digital circuits. 3. No isolation between analog channels in the same group.	
Power Consumption	VB-8T	DC 24V, -10% ~ +5%; 70 mA (Max.)	
	VB-4T	DC 24V, -10% ~ +5%; 45 mA (Max.)	



VB-4PT 4-Channel PT-100 Temperature Input Module
VB-2PT 2-Channel PT-100 Temperature Input Module

- Each input channel can be set its temperature range and resolution independently.
- The 0.1 °C high resolution temperature detection.
- The instrument-class "Dual-Slope ADC" can give accurate and stable measurement values. Also it filters out white noise induced by 50/60Hz power line.
- The Centigrade (°C) or Fahrenheit (°F) measurement values are available.
- Providing the temperature sensors' open circuit detective function.

Item		Specification	
Analog Sensor		Up to 8 / 4 Channel Thermocouples (Type J, K or JIS 1602-1981)	
Unit Type		Centigrade (°C)	Fahrenheit (°F)
Range	K Type	-270.0 ~ +1370.0 °C	-454.0 ~ +2498.0 °F
	J Type	-210.0 ~ +1200.0 °C	-346.0 ~ +2192.0 °F
Digital Output Range		200,000 Reading	
Resolution		0.1 °C	0.18 °F
Overall Accuracy		±0.3% of full scale (compensated range)	
Conversion Speed		The period of conversion is 0.5 sec. ~ 2 sec. (According to the No. of channels is in use at the same group; CH 1~4 are a group, CH 5~8 are another group.)	
Isolation Method		1. The VB-8T / VB-4T has 2/1 group analog input circuit(s). Each group supports 4 channels thermocouple inputs and has its own isolation DC/DC power converter. 2. Photocoupler isolation between 2 analog circuit groups and digital circuits. 3. No isolation between analog channels in the same group.	
Power Consumption	VB-8T	DC 24V, -10% ~ +5%; 70 mA (Max.)	
	VB-4T	DC 24V, -10% ~ +5%; 45 mA (Max.)	



VB-2LC 2-Channel Temperature Control Module

VB-1LC 1-Channel Temperature Control Module

- Equipped with temperature input(s), PID calculation output control(s) and plenty warning modes.
- Providing with the Auto-Tuning function, easily to get the parameters of PID.
- 2 (VB-2LC) / 1 (VB-1LC) temperature input channel(s) (PT-100 RTD or J / K type thermocouple sensor) and 2 / 1 transistor (open collector) output channel(s).
- Providing the temperature sensors' open circuit detective function.
- Providing the Current Transformer detection that can check the status of heater.

Input Feature Specification

Item		Specification	
Module		VB-2LC	VB-1LC
Temperature Input	Number of Input	2 channels	1 channel
	Input Type	K / J / R / S / E / T / B / N / PL II / WRe5-26	
	Measurement Accuracy	Ambient temperature 23°C (73.4°F) ±5°C (9°F): ±0.3% of full scale (compensated range); Ambient temperature 0 to 55°C (32 to 131°F): ±0.7% of full scale (compensated range).	
	Cold Contact Temperature Compensation Error	±2.0°C (±3.6°F) while input value is -70 to +10°C (-94 to +50°F) or +40 to +130°C (+104 to +266°F); ±1.0°C (±1.8°F) while input value is +10 to +40°C (+50 to +104°F).	
	Scale	0.1°C (0.1°F) or 1°C (1°F) depending upon the input mode of the sensors used.	
	Sampling Period	500 ms	
	Effect of External Resistance	Approx. 0.125 μV/Ω	
	Input Impedance	1 MΩ or more	
	Sensor Current	Approx. 0.27 mA (for 100Ω, PT-100)	
	Allowable Input Lead Wire Resistance	10 Ω or less	
	Operation When Input is Disconnected	The output value = 29999 (Upscale)	
	CT Input	Number of Input	2 channels
Current Detector		CTL-12-S36-8 or CTL-6-P-H (manufactured by U.R.D. Co., Ltd.)	
Heater Current Measurement Value		When CTL-12 is used: 0 to 100A; When CTL-6 is used: 0 to 30 A.	
Measurement Accuracy		±5% of input value or 2 A (excluding precision of current detector)	
Sampling Period		1 sec.	

Output Feature Specification

Item		Specification	
Module		VB-2LC	VB-1LC
Number of Output		2 channels	1 channel
Output Type		Open collector transistor output	
Rated Load Voltage		DC 5 ~ 24V (Max. load voltage: DC 30V or less)	
Max. Load Current		100 mA	
"OFF" Status Leakage Current		0.1 mA or less	
"ON" Status Voltage Drop		2.5V (Max.) or 1.0V (typical) at 100 mA	
Control Output Cycle		30 sec. (Variable within range from 1 ~ 100 sec.)	

Performance Specifications, Power Supply and Common Items

Item		Specification
Control Method		Two-position control, PID control (with auto-tuning function) and PI control
Control Operation Period		500 ms
Isolation Method		1. The VB-2LC/ VB-1LC has 2/1 group analog input circuit(s). Each group supports 1 channel PT-100 or Thermocouple inputs and has its own isolation DC/DC power converter. 2. Photocoupler isolation between 2 analog circuit groups and digital circuits.
Power Consumption	VB-2LC	DC 24V, -10% ~ +5%; 70 mA (Max.)
	VB-1LC	DC 24V, -10% ~ +5%; 45 mA (Max.)



VB-1PG Single Axis Pulse Output Positioning Control Module

- Equipped with seven operation modes, easy to perform positioning control.
- Up to 100 kHz output pulse chains.
- Providing two pulse output formats: Forward (FP) / Reverse (RP) pulse or pulse chains (PLS) + direction control (DIR) output.
- Providing with DOG, PGO and STOP input terminals.
- Multiple axes can be controlled by connecting multiple VB-1PG modules.

Item		Specification
Number of Control Axis		1 axis; up to 16 independent axes can be controlled by a VB Series PLC Main Unit
Operation Speed		Pulse Output Frequency: 10 Hz~100 KHz Optional units: PLS/sec, cm/min, 10deg/min and inch/min
Setting Position Data Range		0 ~ ±999,999,999 Absolute position specification or Relative travel specification can be selected Command units: PLS, μm, mdeg or 10-4 inch Multiplication of 10°, 101, 102 or 103 can be used for position data input
Pulse Output Format		Output FP (forward pulse) / RP (reverse pulse) or PLS (pulse chain) with DIR (direction control) can be selected. Open collector transistor output: DC 5~24V, 20 mA or less
External Input / Output Terminals		Input 3 points: (STOP/DOG) DC 24V, 7 mA; (PGO) DC 24V, 20 mA Output 3 points: (FP/RP/CLR) DC 5 ~ 24V, 20 mA or less Photocoupler isolation with LED indicator for all points
Power Consumption	For Input Signal	DC 24V ± 10%, < 50 mA, external power supply
	For Internal Control	DC 5V, 50 mA, internal PLC power supply
	For Pulse Output	DC 5 ~ 24V, < 35 mA; from VIN servo-amplifier or external power supply



VB-1HC High Speed Counter Module

- One-phase, two-phase or A/B-phase pulse input is available.
- A/B-phase pulse counting can be set to ×1, ×2 or ×4 multiplication mode.
- Equipped with the hardware comparator for its two output points.
- Providing software/hardware "Disable Counting" and "Preset" functions.
- Each input is available to use 5V, 12V or 24V signal (depending on the connection terminal).

Item		Specification				
Input Signal	Max. Frequency	One-Phase Input	Two-Phase Input	A/B-Phase Input		
		150KHz	100KHz	×1 Count	×2 Count	×4 Count
	Signal Detail	A: A-Phase Signal B: B-Phase Signal P: Preset Signal D: Disable Signal		A24+, B24+, P24+, D24+ : DC 24V ± 10% A12+, B12+, P12+, D12+ : DC 12V ± 10% A5+, B5+, P5+, D5+ : DC 5V ± 10% Operating Current: 14 mA ± 10%		
Count Specification	Count Mode	Two-Phase or A/B-Phase: Automatic Up/Down counting One-Phase: Up/Down counting, determined by PLC instructions or an input signal				
	Count Range	32-bit Binary Counter: -2,147,483,648 ~ +2,147,483,647 16-bit Binary Counter: 0 ~ +65,535				
	Comparison Method	When the Current Value = Setting Value, the output coil turns "ON". By a reset command from the PLC, the coil can be reset to "OFF". Both YH1 and YH2 are using its hardware CPU to process the outputs directly.				
Output Signal	Output Type	Both YH1 and YH2 are NPN open collector transistor output.				
	Output Capacity	DC 5 ~ 24V, 0.5A				
Power Consumption		DC 5V, 85 mA (Internal power supply from the Main Unit or Powered Extension Unit)				

◆ VB-PWR Power Expansion Module



Item	Specification
Input Voltage / Frequency	Wide range AC 100 ~ 240V, +10%/-15%; 50/60Hz
Max. Allowable Momentary Power Failure Period	Within 10 ms
Power Fuse	250V, 2A
Power Consumption	40VA
Rated Output Power	DC 5V, 400 mA; for the connected modules (at the right side of the VB-PWR) DC 12V, 800 mA; for the connected modules (at the right side of the VB-PWR) DC 24V, ± 15%, 500 mA; output from the terminal block for sensors
Number of Available Expansion Modules	The expansion modules connect with the right side of VB-PWR should conform to the following two power requirements: 1. [(Number of Expansion Modules) + (Number of Special Modules × 2)] ≤ 12 2. Output points: [(Number of Relay is "ON" × 6) + (Number of Transistor is "ON")] ≤ 288

◆ VB-30PS Power Supply Module



Item	Specification
Input Voltage	AC 110V or AC 220V (selected by the terminal input), ±20%
Power Frequency	50 / 60Hz
Max. Allowable Momentary Power Failure Period	Within 10 ms
Power Fuse	250V, 2A
Power Consumption	50VA
Rated Output Power	DC 5V ±5%, 200mA, output from the terminal block DC 24V ±5%, 1.2A, output from the terminal block
Mount Method	DIN Rail installation or fixed by screws

◆ DAP-100 Configuration Panel



Item	Specification
Product Composition	Transparently decorative panel for the Multi-Display + 4-key setting keypad
Surface Material	Glassy PC plastic with thickness of 0.254mm (10mil)
Keypad Specification	12×12 mm Tact Switch
Button Life (MTTF)	500,000 times
Interface To Link Up With a PLC	Occupies 4 PLC input points
Connection Type	PCB-Type terminal block
Dimensions (W×H×D)	Transparently decorative panel: 110×45×0.254 mm (4.33"×1.77"×.01") 4-key setting keypad: 110×45×2.4 mm (4.33"×1.77"×.94")

◆ Memory Card Slot Expansion Cards



VB-RTC Real Time Clock Expansion Card

- With in of the Real Time Clock Expansion Card, the PLC will enable to do the automatic control according to date and time.
- To indicates the year, month, day, hour, minute, second and week.
- The battery life is around 5 years at 25°C 77°F.
- When the battery power is too low, the special relay M9005 will turn "ON".



VB-MP1R Program Memory Card



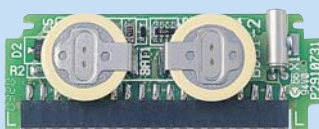







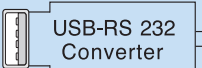

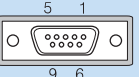

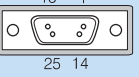



- The 16K Steps Program Memory Card. Use a Flash ROM, can rewrite over 10,000 times. (Only 8K steps capacity, if it is installed in a VBO series Main Unit.)
- Providing program upload/download function, easy for program copy and machine maintenance.
- Including the RTC function, the battery life is around 5 years at 25°C 77°F. When the battery power is too low, the special relay M9005 will turn "ON".

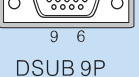

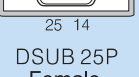
VB-DB1R Data Bank Expansion Card

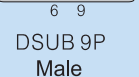
- The 128K words Data Storage Card. The data storage is using SRAM, and the Lithium batteries are used for latched data.
- Providing storage room for extensive data which needs the latched function. The VB-DB1R is usually used for storage formula data or long-time data collection.
- Using the DBWR and DBRD instructions to access data in the VB-DB1R.
- The development software Ladder Master is available to modify, archive and upload/download the data in the VB-DB1R.
- Including the RTC function, the battery life is around 5 years at 25°C 77°F.
- When the battery power is too low, the special relay M9005 will turn "ON".

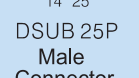
◆ Connecting Cables

Model	Physical Demonstration	Connection Schematics	Application
VBUSB-200 (Length: 200cm 6'7")		<p>To Computer</p>  <p>USB A-Type Connector</p> <p>To PLC</p>  <p>USB A-Type Connector</p>	<ul style="list-style-type: none"> PC USB Port ↔ VB, VH or M Series PLC
MWPC-200 (Length: 200cm 6'7")		 <p>DSUB 9P Female Connector</p>  <p>USB A-Type Connector</p>	<ul style="list-style-type: none"> PC ↔ VB, VH or M Series PLC
MWPC25-200 (Length: 200cm 6'7")		 <p>DSUB 25P Female Connector</p>  <p>USB A-Type Connector</p>	<ul style="list-style-type: none"> PC ↔ VB, VH or M Series PLC Hitech HMI ↔ VB, VH or M Series PLC
MWMD-200 (Length: 200cm 6'7")		 <p>DSUB 9P Male Connector</p>  <p>USB A-Type Connector</p>	<ul style="list-style-type: none"> MODEM ↔ VB, VH or M Series PLC EASY VIEW HMI ↔ VB, VH or M Series PLC
VBPC09-200 (Length: 200cm 6'7")		 <p>DSUB 9P Female Connector</p>  <p>JST 4P Female Connector</p>	<ul style="list-style-type: none"> PC ↔ VB or VH Series PLC
VBPC25-200 (Length: 200cm 6'7")		 <p>DSUB 25P Female Connector</p>  <p>JST 4P Female Connector</p>	<ul style="list-style-type: none"> PC ↔ VB or VH Series PLC Hitech HMI ↔ VB or VH Series PLC
VBMD09-200 (Length: 200cm 6'7")		 <p>DSUB 9P Male Connector</p>  <p>JST 4P Female Connector</p>	<ul style="list-style-type: none"> MODEM ↔ VB or VH Series PLC Easy View HMI ↔ VB or VH Series PLC
VBFDHMI-200 (Length: 200cm 6'7")		 <p>DSUB 25P Male Connector</p>  <p>JST 4P Female Connector</p>	<ul style="list-style-type: none"> FUJI HMI ↔ VB or VH Series PLC DIGITAL HMI ↔ VB or VH Series PLC ProFace HMI ↔ VB or VH Series PLC
VBEC-050 (Length: 50cm 19.7")		—	<ul style="list-style-type: none"> Extended cable for a VB Series PLC Expansion Unit/Module. (Since the data transfer in the extended cable is unprotected, it is easy to get interference. So during the wiring job, should keep away from the interference.)
VBEC-100 (Length: 100cm 3'3")			

◆ 94mm Model

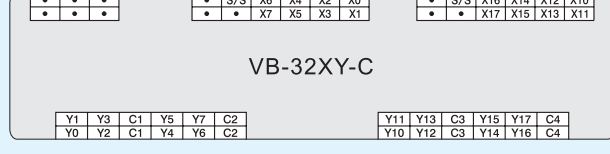
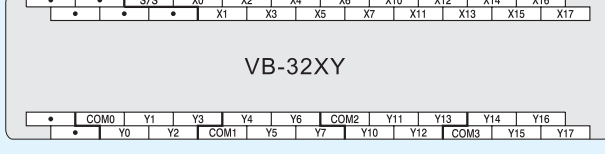
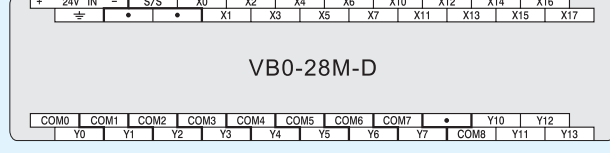
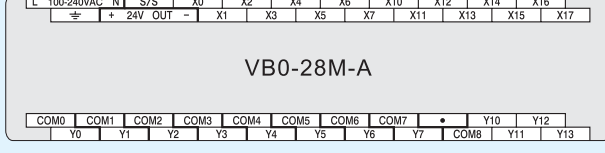
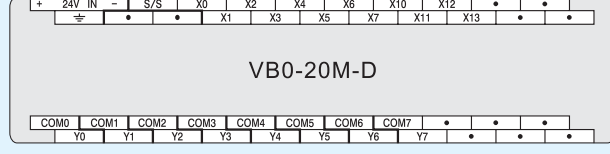
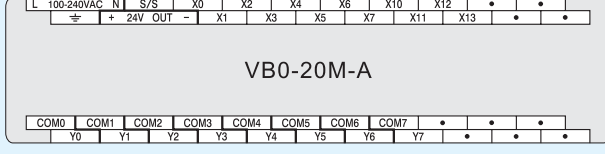
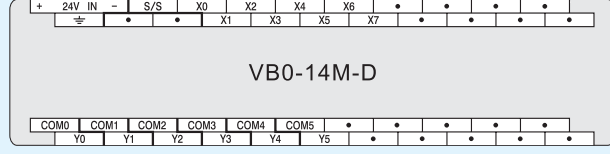
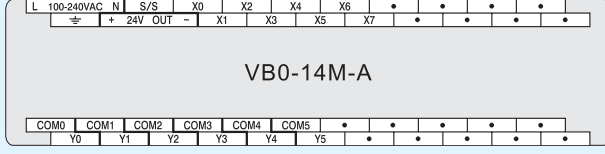
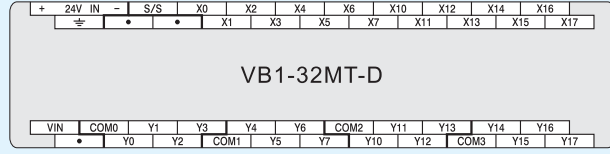
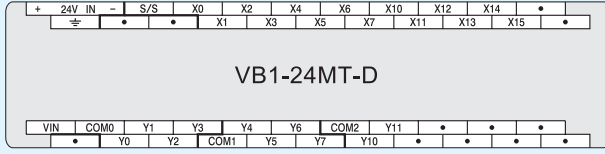
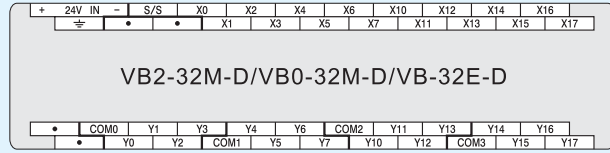
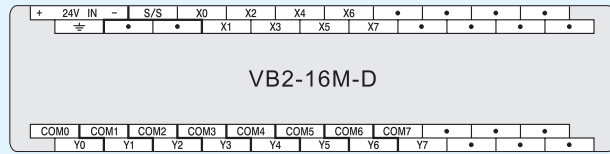
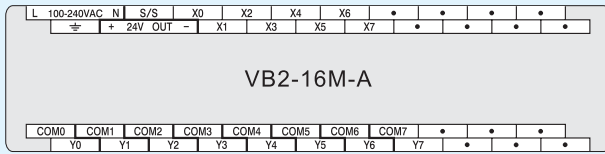
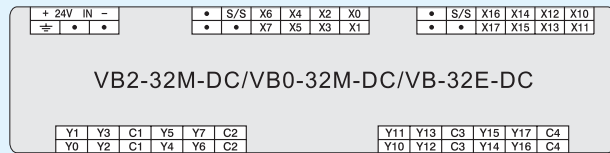
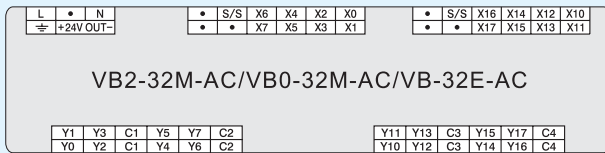
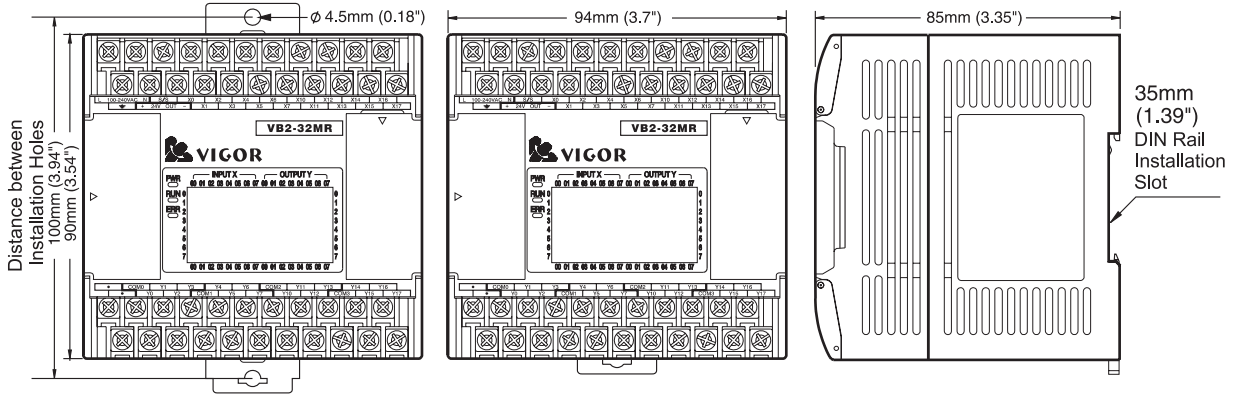

Dimension and Terminal Layouts

◆ 48mm Model

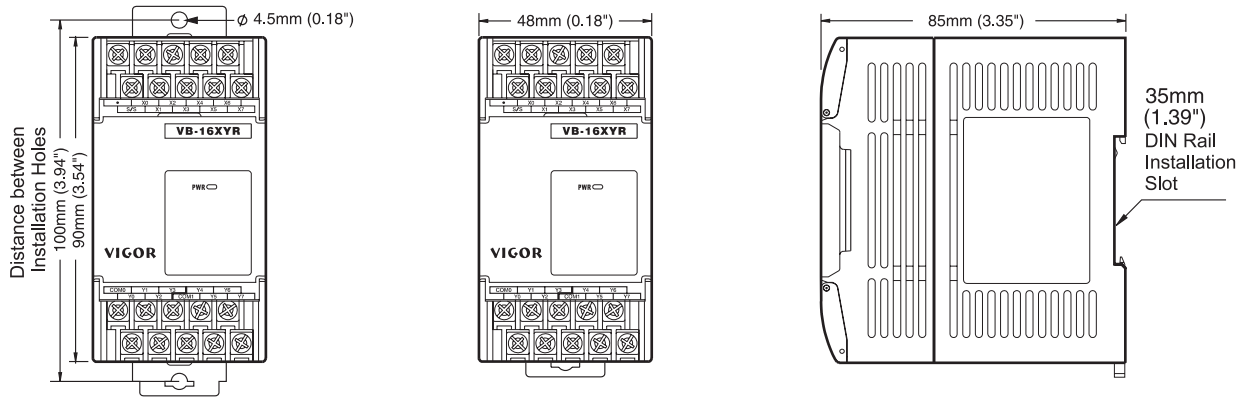

<p>VB1-14MT-D</p> <p>S/S X0 X1 X2 X3 X4 X5 X6 X7</p> <p>24V IN - Y0 Y2 Y4</p> <p>COM0 Y1 Y3 Y5</p>	<p>VB-8X-C</p> <p>S/S X6 X4 X2 X0</p> <p>X7 X5 X3 X1</p>	<p>VB-16X-C</p> <p>S/S X6 X4 X2 X0</p> <p>X7 X5 X3 X1</p> <p>X11 X13 X15 X17</p> <p>X10 X12 X14 X16 S/S</p>
<p>VB-8Y-C</p> <p>Y1 Y3 C1 Y5 Y7 C2</p> <p>Y0 Y2 C1 Y4 Y6 C2</p>	<p>VB-16XY-C</p> <p>S/S X6 X4 X2 X0</p> <p>X7 X5 X3 X1</p> <p>Y1 Y3 C1 Y5 Y7 C2</p> <p>Y0 Y2 C1 Y4 Y6 C2</p>	<p>VB-8X</p> <p>X0 X2 X4 X6</p> <p>S/S X1 X3 X5 X7</p>
<p>VB-8Y</p> <p>COM0 Y1 Y3 Y4 Y6</p> <p>Y0 Y2 COM1 Y5 Y7</p>	<p>VB-16Y</p> <p>COM0 Y1 Y3 Y4 Y6</p> <p>Y0 Y2 COM1 Y5 Y7</p> <p>COM2 Y11 Y13 Y14 Y16</p> <p>Y10 Y12 COM3 Y15 Y17</p>	<p>VB-16XY</p> <p>X0 X2 X4 X6</p> <p>S/S X1 X3 X5 X7</p> <p>COM0 Y1 Y3 Y4 Y6</p> <p>Y0 Y2 COM1 Y5 Y7</p>
<p>VB-2VC</p> <p>24V IN - P+ P-</p> <p>VS IN F+ F-</p>	<p>VB-4AD</p> <p>AIN1+ AIN1- FG AIN3+ AIN3-</p> <p>AIN2+ AIN2- FG AIN4+ AIN4-</p> <p>24V IN - COM VOUT1 IOUT1</p> <p>10V OUT - VOUT2 IOUT2</p>	<p>VB-2DA</p> <p>24V IN - COM VOUT1 IOUT1</p> <p>VS VOUT2 IOUT2</p>
<p>VB-3A</p> <p>AIN1+ AIN1- FG AIN3+ AIN3-</p> <p>AIN2+ AIN2- FG AIN4+ AIN4-</p> <p>24V IN - COM VOUT1 IOUT1</p> <p>10V OUT - VOUT2 IOUT2</p>	<p>VB-6A</p> <p>AIN1+ AIN1- FG AIN3+ AIN3-</p> <p>AIN2+ AIN2- FG AIN4+ AIN4-</p> <p>24V IN - COM VOUT1 IOUT1</p> <p>10V OUT - VOUT2 IOUT2</p>	<p>VB-4DA</p> <p>24V IN - COM VOUT1 IOUT1</p> <p>VS VOUT2 IOUT2</p> <p>VOUT3 IOUT3</p> <p>COM1 IOUT1 VOUT2 COM3 IOUT3</p>
<p>VB-2PT</p> <p>FG PTB1 PTB2</p> <p>PTA1 PTA2</p> <p>24V IN - COM VOUT1 IOUT1</p> <p>10V OUT - VOUT2 IOUT2</p>	<p>VB-4PT</p> <p>FG PTB1 PTB2</p> <p>PTA1 PTA2</p> <p>24V IN - PTA3 FG PTA4</p> <p>PTB3 PTB4</p>	<p>VB-1LC</p> <p>COM1 PTA TC+PTB TC-PTB</p> <p>OUT1 FG CT CT</p> <p>24V IN - COM VOUT1 IOUT1</p> <p>10V OUT - VOUT2 IOUT2</p>
<p>VB-1PG</p> <p>STOP DOG PGO+ PGO-</p> <p>S/S S/S</p> <p>VIN FP CLR</p> <p>COM0 RP COM1</p>	<p>VB-1HC</p> <p>A24+ A5+ B24+ B5+ YH1+</p> <p>A12+ A- B12+ B- YH1-</p> <p>D24+ D5+ P24+ P5+ YH2+</p> <p>D12+ DIS- P12+ PRE- YH2-</p>	<p>VB-PWR</p> <p>L 100-240VAC N 24V OUT -</p> <p>INPUT: 100-240VAC</p> <p>OUTPUT: 5V 0.4A / 12V 0.8A / 24V 0.5A</p>
<p>VB-1COM</p> <p>232G RX TX</p> <p>24V IN - SHORT FOR TR</p> <p>485G D+ D-</p>	<p>VB-CADP</p> <p>485G D+ D- SHORT FOR TR CP2</p> <p>232G RX TX CD</p> <p>24V IN - SHORT FOR TR CP3</p> <p>485G D+ D-</p>	<p>VB-30PS</p> <p>L 110/220VAC N 5V OUT -</p> <p>SHORT FOR 110VAC 24V OUT -</p> <p>INPUT: 110 / 220VAC SELECTIVE</p> <p>OUTPUT: 24V 1.2A / 5V 0.2A</p>

MS Windows®-based Programming Tool : Ladder Master

The Ladder Master is a Ladder-Diagram programming software, which is based on the Microsoft® Windows® operating system and specially developed for M, VB and VH Series PLC. With the use of a mouse and keyboard, it features good friendliness, easy to learn, understand and operate.

The Ladder Master provides powerful and complete functions in programming, operation monitoring and system maintenance. It will effectively help you to complete the job.

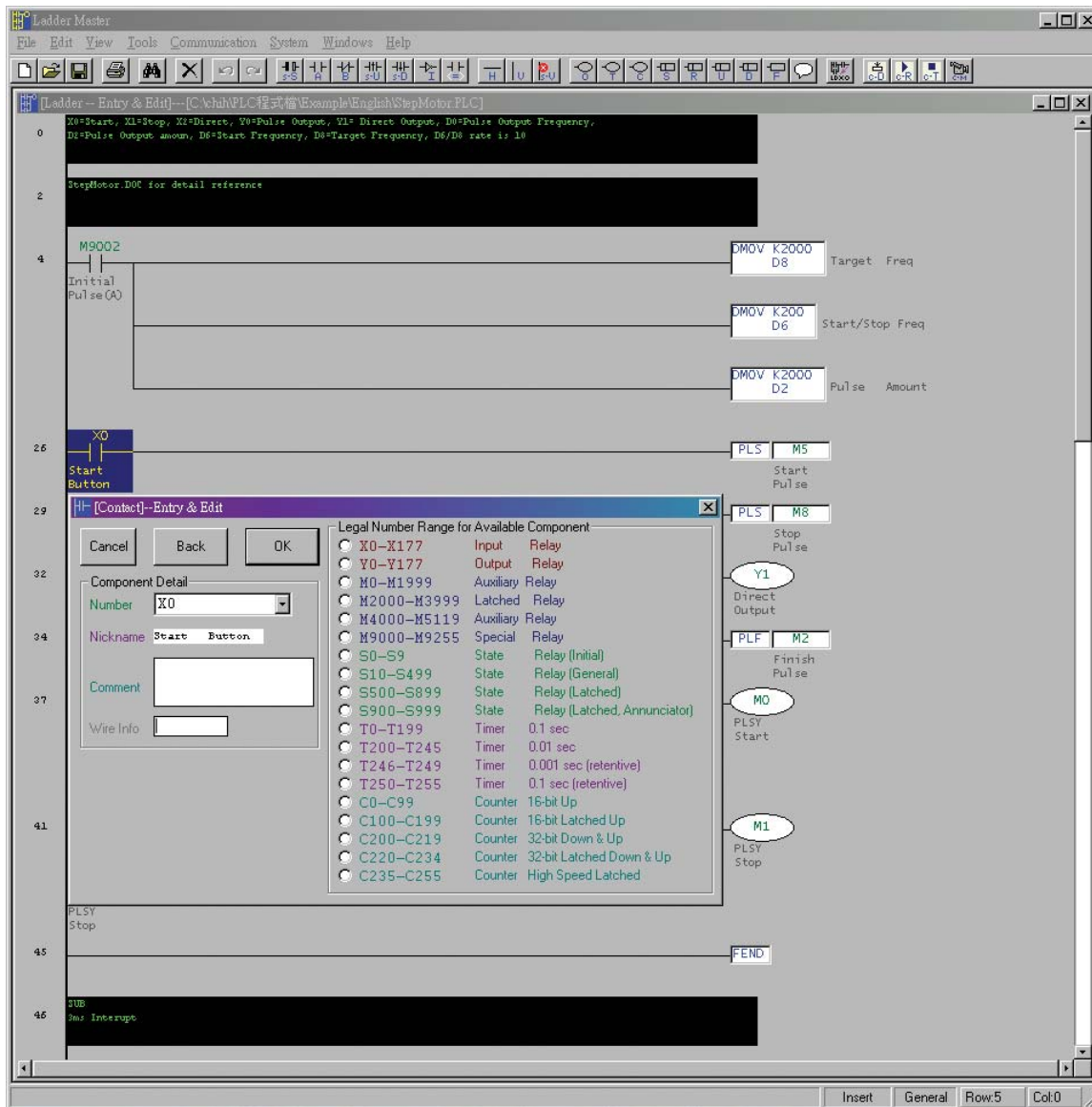

- The operating habit is correspond with the Windows® environment, which has the advantage of easy to learn, application and good friendliness.
- Providing various language versions, such as Traditional Chinese, Simple Chinese and English versions, that are convenient for different language users.
- Providing direct connection and MODEM connection functions, which allows remote program modification and data monitoring.
- Its quick input mode enhances the programming efficiency by processing diagram input and component assignation separately.
- Featuring the Insert, Delete, Cut, Copy, Paste, Undo and Export/Import functions.
- Providing 16 letters of component annotations plus sectional program annotations, which can be fully express the program denotation and improve program readability.
- During the programming processes, the Ladder Master provides the guidelines of reference, which will give the real-time error retrieved and the instant prompts.

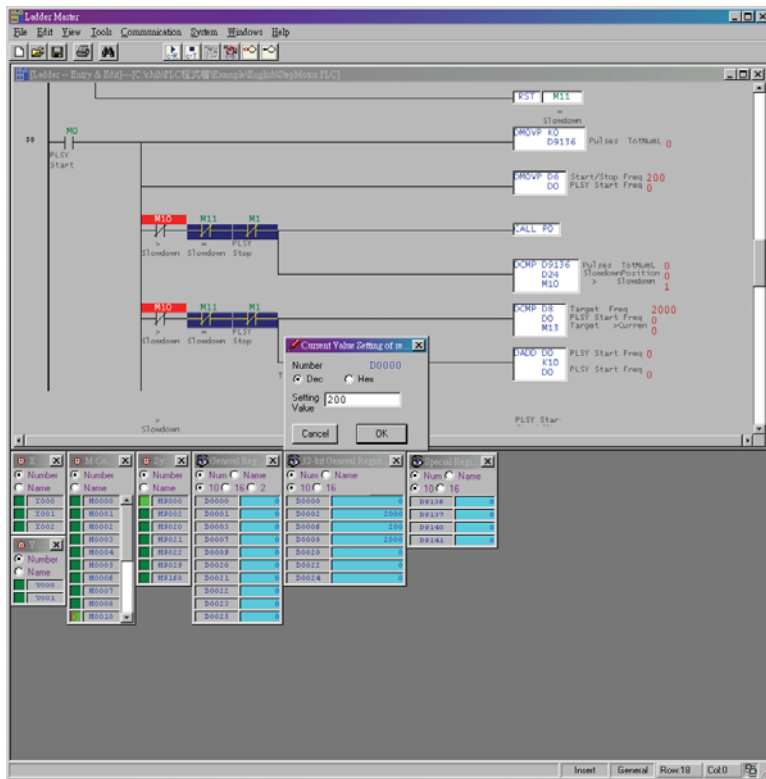

- Simultaneous monitoring of the ladder diagram and component status, allows efficiently program debugging.
- Selectable group monitoring function for component facilitate the use of the monitoring layout.
- Providing component enforce functions: contacts force "ON"/"OFF" and Registers' present value input.
- For easier test run, debug and system maintenance, the monitoring function of Ladder Master could select monitored components. It also allows to keep the assigned monitoring page.
- The system configuration is set by dialogue box, enables easy system parameter settings.
- The print function is available for the program itself and parameter list, easy to record and create of engineering document/data.
- For the latched area, File Register and Data Bank, it provided the editing and archiving functions, which offering the easy system maintenance and duplication of machine data.

Palm OS™-based PDA Programming Tool : NeoTouch

The NeoTouch is an application program interface, which is specially developed for M, VB and VH Series PLC. The NeoTouch is designed to install at a Palm OS™ PDA, it offers many functions better than those of the Handy Programming Panel. This advanced design idea creates a new generation of PLC program writers.

- A PDA has the features compactness and mobility with the self-contained power, it can operate independently.
- The touch screen cooperated with the dialogue boxes which allows to learn and operation easily.
- The larger screen could display 11 lines of instructions in one page, that is very helpful for the programming and operation monitoring.
- Featuring the modern programming edit functions, such as Cut, Copy, Paste and Undo.
- The powerful component replacement function, that enables to exchange multiple components at once and it is good for various component types.
- Allowing to monitor the program and selected components simultaneously. The monitored components could be changed anytime by the demand of application.
- Providing component enforce functions: contacts force "ON"/"OFF" and Registers' present value input.



PDA-based NeoTouch

Item	Model	Main Specification
VB0 Series Main Unit	VB0-14M★◆	8 points, DC 24V Signal Input; 6 points Output; the barrier terminal style I/O
	VB0-20M★◆	12 points, DC 24V Signal Input; 8 points Output; the barrier terminal style I/O
	VB0-28M★◆	16 points, DC 24V Signal Input; 12 points Output; the barrier terminal style I/O
	VB0-32M★◆	16 points, DC 24V Signal Input; 16 points Output; the barrier terminal style I/O
	VB0-32M★◆C	16 points, DC 24V Signal Input; 16 points Output; the ATX connector I/O (including cables)
VB1 Series Main Unit	VB1-14MT-D	DC 24V Power Input; 8 points, DC 24V Signal Input; 6 points NPN Transistor Output; the barrier terminal style I/O
	VB1-24MT-D	DC 24V Power Input; 14 points, DC 24V Signal Input; 10 points NPN Transistor Output; the barrier terminal style I/O
	VB1-32MT-D	DC 24V Power Input; 16 points, DC 24V Signal Input; 16 points NPN Transistor Output; the barrier terminal style I/O
VB2 Series Main Unit	VB2-16M★◆	8 points, DC 24V Signal Input; 8 points Output; the barrier terminal style I/O
	VB2-32M★◆	16 points, DC 24V Signal Input; 16 points Output; the barrier terminal style I/O
	VB2-32M★◆C	16 points, DC 24V Signal Input; 16 points Output; the ATX connector I/O (including cables)
Expansion Unit	VB-32E★◆	16 points, DC 24V Signal Input; 16 points Output; the barrier terminal style I/O
	VB-32E★◆C	16 points, DC 24V Signal Input; 16 points Output; the ATX connector I/O (including cables)
Expansion Module	VB-32XY★	16 points, DC 24V Signal Input; 16 points Output; the barrier terminal style I/O
	VB-16XY★	8 points, DC 24V Signal Input; 8 points Output; the barrier terminal style I/O
	VB-16X	16 points, DC 24V Signal Input; the barrier terminal style Input
	VB-16Y★	16 points Output; the barrier terminal style Output
	VB-8XY★	4 points, DC 24V Signal Input; 4 points Output; the barrier terminal style I/O
	VB-8X	8 points, DC 24V Signal Input; the barrier terminal style Input
	VB-8Y★	8 points Output; the barrier terminal style Output
	VB-32XY★-C	16 points, DC 24V Signal Input; 16 points Output; the ATX connector I/O (including cables)
	VB-16XY★-C	8 points, DC 24V Signal Input; 8 points Output; the ATX connector I/O (including cables)
	VB-16X-C	16 points, DC 24V Signal Input; the ATX connector Input (including cables)
	VB-8X-C	8 points, DC 24V Signal Input; the ATX connector Input (including cables)
	VB-8Y★-C	8 points Output; the ATX connector Output (including cables)
	Special Module	VB-4AD
VB-2DA		2 channels, 12-bit resolution Analog Output Module; selectable Voltage or Circuit Output
VB-4DA		4 channels, 8-bit resolution Analog Output Module; selectable Voltage or Circuit Output
VB-3A		2 channels Input, 1 channel Output, 12-bit resolution Analog I/O Module; selectable Voltage or Circuit I/O
VB-6A		4 channels Input, 2 channels Output, 12-bit resolution Analog I/O Module; selectable Voltage or Circuit I/O
VB-2VC		2 channels Valve Controls Modules; 12 bit DAC, up to 1.111A/Ch
VB-4T		4 channels Temperature Input Module
VB-8T		8 channels Temperature Input Module
VB-2PT		2 channels Temperature Input Module
VB-4PT		4 channels Temperature Input Module
VB-1LC		1 channel Temperature Control Module
VB-2LC		2 channels Temperature Control Module
VB-1PG		Single-axle Pulse Output Position Control Module; Output Pulse Frequency: 10 ~ 100Kpps
VB-1HC		1 channel High Speed Counter Module; Max. 150KHz Input; 2 hardware comparator outputs
VB-1COM		Serial-Line Communication Module; Photocoupler Isolated RS-232 / RS-485 Interface; Communication Distance of RS-485 is up to 1000M 3280'
Communication Module	VB-485A	RS-485 Communication Module; Photocoupler Isolated; Max. Distance: 1000M 3280'
	VB-CADP	Dual-Port Communication Expansion Module; one Isolated RS-232 / RS-485 Port and one Isolated RS-485 Port; Max. Distance: 1000M 3280' (RS-232: 15M 49')
Communication Card	VB-232	RS-232C Communication Expansion Card
	VB-485	RS-422 / RS-485 Communication Expansion Card; non-Isolated; Max. Distance: 50M 164'
Memory Card Slot Expansion Card	VB-MP1R	16K Steps Flash ROM Program Memory Card (Only 8K Steps for the VB0); including the RTC (Real Time Clock) function
	VB-RTC	RTC (Real Time Clock) Expansion Card
	VB-DB1R	128K Words Data Storage Expansion Card; including the RTC (Real Time Clock) function
Connection Cable	VBUSB-200	Cable between a PLC (CP1 A-type USB) and Computer A-type USB Port; Length: 200cm 6'7"
	MWPC-200	Cable between a PLC (CP1 A-type USB) and Computer (9-pin female connector); Length: 200cm 6'7"
	MWMD-200	Cable between a PLC (CP1 A-type USB) and MODEM (9-pin male connector) with a length of 200cm 6'7"
	MWPC25-200	Cable between a PLC (CP1 A-type USB) and Computer (25-pin female connector); Length: 200cm 6'7"
	VBPC09-200	Cable between a PLC (CP1 JST 4P) and Computer (9-pin female connector); Length: 200cm 6'7"
	VBMD09-200	Cable between a PLC (CP1 JST 4P) and MODEM (9-pin male connector); Length: 200cm 6'7"
	VBPC25-200	Cable between a PLC (CP1 JST 4P) and Computer (25-pin female connector); Length: 200cm 6'7"
	VBFDHMI-200	Cable between a PLC (CP1 JST 4P) and Fuji, ProFace HMI (25-pin male D-SUB); Length: 200cm 6'7"
	VBEC-050	VB Series PLC Expansion Extended cable; Length: 50cm 19.7"
VBEC-100	VB Series PLC Expansion Extended cable; Length: 100cm 3'3"	
Power Supplier	VB-30PS	30W power supply; power input: AC 110V or AC 220V; outputs: DC 24V 1.2A and DC 5V 0.2A
Setting Panel	DAP-100	Transparently decorative panel for the Multi-Display + 4-key setting keypad; for incorporated with the Multi-Functional Display to set various parameters

★ indicates the control output type R: Relay output T: NPN Transistor output P: PNP Transistor output
 ◆ indicates the power type A: AC 100 ~ 240V -15%/+10%, 50/60 Hz input; with a DC 24V ± 15%, 420mA output for sensors
 D: DC 24V -15%/+20% input

VIGOR ELECTRIC

VIGOR ELECTRIC CORP.

Taipei Head Office / TEL:886-2-2620-4393

FAX:886-2-2620-4976

<http://www.vigorplc.com>